



Why Filter Fuels & Lubricants?

Today's sophisticated equipment, such as diesel engines with increased injection pressures, requires higher cleanliness levels than ever before. Donaldson bulk filtration systems save on costly component replacement, prevent unplanned downtime and prevent a decrease in fuel efficiency due to injector wear. In short, **Donaldson reduces your total cost of ownership**. Learn more about all things related to diesel fuel at MyCleanDiesel.com.



Table of Contents

- 3 Why Do I Need Clean Fuel?
- 4 What is Clean Fuel?
- 6 How Do I Get Clean Fuel?
- 8 Clean Diesel Kits
- 9 Clean Diesel Carts
- 10 Fuel and Lubricant Filters
- 12 Filter Heads
- 14 Manifolds
- 16 Bulk hP Filters and Heads
- 18 Filter Flow Rates and Pressure Drops
- 20 T.R.A.P.™ Breather Assemblies
- 23 Reservoir Air Dryer
- 24 Clean DEF Filter
- 26 Accessories
- 28 System & Sizing

DIESEL IS DIRTY.

DIRT IS BAD.

REMOVE THE DIRT. ACHIEVE MORE.

As diesel travels from refinery to terminal locations to local bulk storage and finally to your bulk tank, it picks up contamination that is **deadly to today's engines.**

Your local distributor likely delivers diesel that meets or exceeds fuel-industry standards for cleanliness. This may **not be clean enough** for your equipment.

By filtering out dirt, water and other contaminants before your fuel ever touches your equipment, you'll minimise costly downtime, **Keep Running** and **Achieve More.**

GET A CLEAN SOLUTION.

To ensure that you're pumping clean, dry fuel into your equipment, call or email a Donaldson Clean Solutions expert. No matter where you are or the size of your operation, there's a Clean Solution that will help you **Achieve More.**





Achieving the Target Cleanliness of a Fluid

ISO 4406 contamination codes are a way to express fluid cleanliness. The three numbers correspond to the number of particles 4 microns and larger, 6 microns and larger, and 14 microns and larger present in the fluid. This page illustrates what it means to start with a contamination of ISO 22/21/18 and target a cleanliness of ISO 14/13/11.

ISO 4406 CONTAMINATION CODES

Range of number of particles per 100 milliliters

CODE	MORE THAN	UP TO & INCLUDING
24	8,000,000	16,000,000
23	4,000,000	8,000,000
22	2,000,000	4,000,000
21	1,000,000	2,000,000
20	500,000	1,000,000
19	250,000	500,000
18	130,000	250,000
17	64,000	130,000
16	32,000	64,000
15	16,000	32,000
14	8,000	16,000
13	4,000	8,000
12	2,000	4,000
11	1,000	2,000
10	500	1,000
9	250	500
8	130	250
7	64	130
6	32	64
5	16	32
4	8	16
3	4	8
2	2	4
1	1	2

ISO
22 / 21 / 18

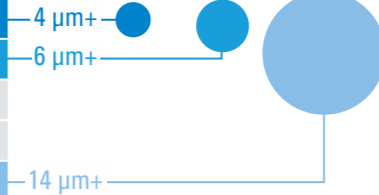

RECOMMENDED ISO CLEANLINESS RATINGS

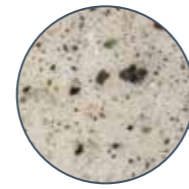

ISO 22/21/18
Typical cleanliness as fluid goes into your equipment



ISO 14/13/11
Target rating for diesel fuel



ISO 16/14/11
Target rating for hydraulic/transmission oils

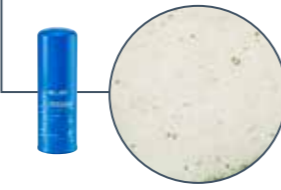

ISO 18/16/13
Target rating for heavy gear/engine oils



ISO
14 / 13 / 11

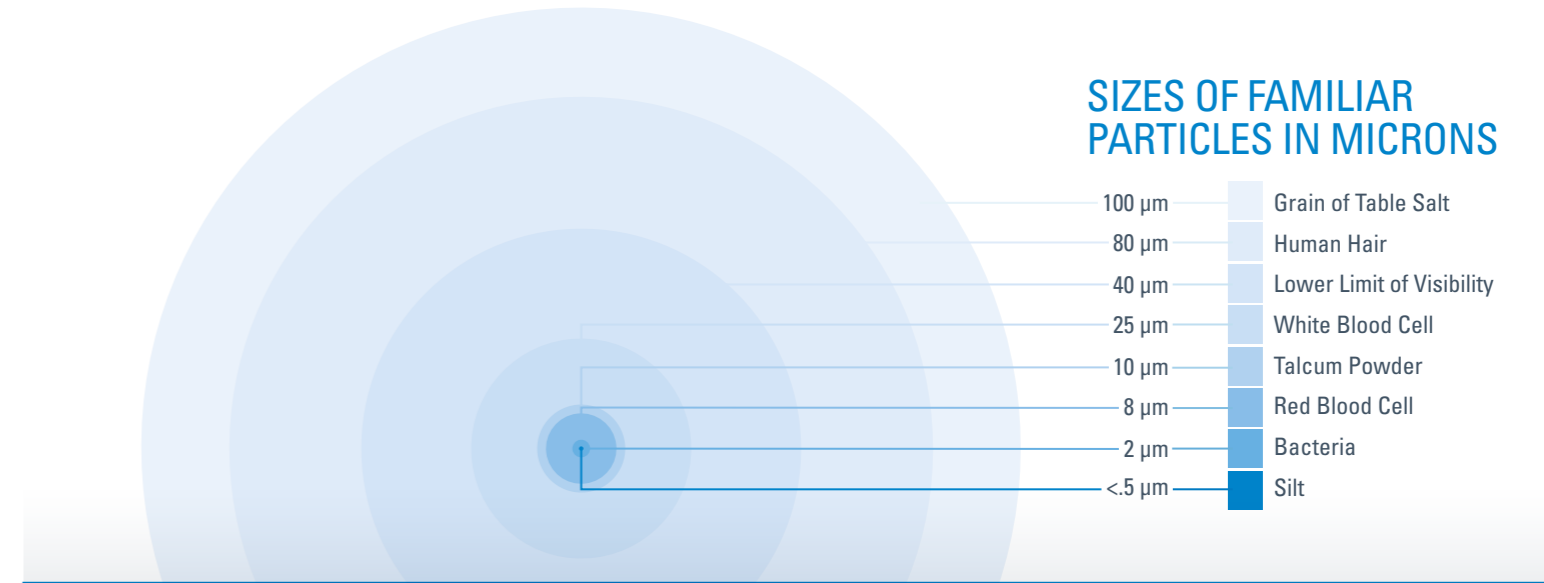

Donaldson Delivers Water Protection

Are your bulk fluids passing large amounts of free water downstream – contaminating vehicles and equipment?

Donaldson's water absorbing filter with super absorbent polymer media, DBB0248, will stop flow if large amounts of free water are detected in your ethanol-free fluids. Designing systems with water absorbing filters requires careful sizing considerations. A Donaldson specialist will assist in configuring a system that meets your specific needs for flow and pressure drop.



Choosing the Ideal Filters for Your System Doesn't Need to be Complicated

- 1 Select the **right filter** to achieve **targeted ISO cleanliness**. Proper design of the system will help avoid unnecessary costs.
- 2 Determine the **working pressure** of the system and select the filter range compatible with that pressure.
- 3 Different **types of fluids** have different properties. **Fluid viscosity** plays an important role in restricting the flow through filters. Select a filter that has compatible media-to-fluid properties and will maintain adequate flow and avoid excessive pressure drops. See pages 18-19 for filter flow rates and pressure drops.



Donaldson Delivers

Superior Bulk Fluid Filtration

- Lower Total Cost of Ownership
- Avoid Unplanned Downtime
- Maximise Fuel Efficiency
- Low Installation Costs
- Custom Designs

- Modular Solutions
- Compact Installation
- Low Inventory Costs
- Easily Shipped
- Easily Serviced

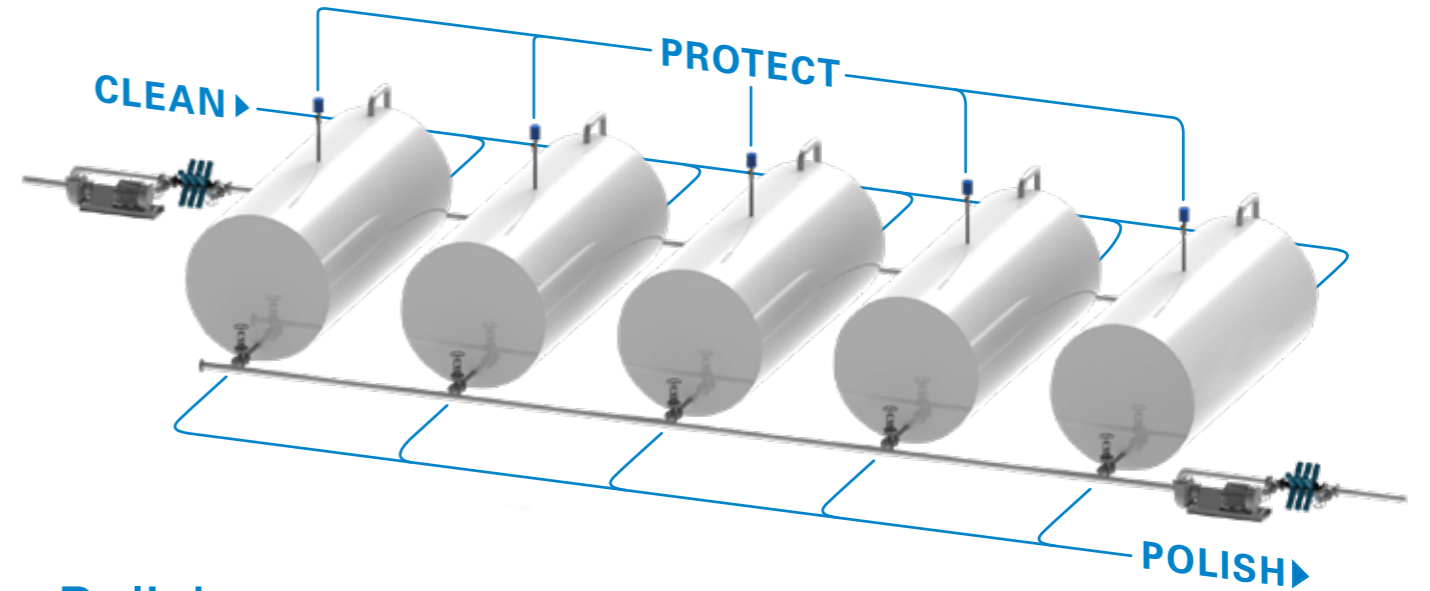

Clean.

Donaldson single-pass filtration on the inlet removes contamination before it can enter your storage tank.

Compact and easy to replace, Donaldson filters are an important line of defense in maintaining fluid quality and can be configured for high flow rates while minimising pressure drop.

Protect.

T.R.A.P.™ Breathers and Reservoir Air Dryers reduce the risk of moisture and contaminants entering a bulk storage tank so fluids are kept clean and dry. Used together, they'll help guard fluids from free water, airborne contamination and microbial growth for as long as they stay in storage.

Polish.

Unstable fluids and the tank itself can be a source of contamination. Final filtration on the outlet with Donaldson filters ensures that targeted ISO cleanliness levels are achieved before fluids are pumped into your equipment.

Achieve More.





Clean Diesel Kits

Donaldson Clean Diesel Kits are the answer to your fuel cleanliness worries. You can't always control the cleanliness of diesel fuel delivered to you, but you can control how clean it is when you pump it into your vehicles and equipment. Donaldson Clean Diesel Kits are easy to install on any fuel dispenser and come with everything needed to filter out even the finest contaminants before they enter your equipment's fuel system.

FEATURES

- Easy to install
- Provides filtration to ISO 14/13/11 diesel cleanliness in a single pass
- Recommended for all diesel and biodiesel blends

APPLICATIONS

- Diesel fuel dispensers
- Mobile service trucks
- Slip tanks



Series Filtration

Part Number	X900098	P506073	X900096	X900018	X900097
Max. Flow Range	121 lpm	189 lpm	189 lpm	375 lpm	375 lpm
Fluid Compatibility	All diesel fuels				
Target ISO Cleanliness	16/14/11	14/13/11	16/14/11	14/13/11	16/14/11
Micron Rating & Efficiency	7 micron @ Beta 2000	4 micron @ Beta 2000	7 micron @ Beta 2000	4 micron @ Beta 2000	7 micron @ Beta 2000
Working Pressure	350 psi / 2413 kPa / 24.1 bar				
Element Collapse Pressure	150 psi / 1034 kPa / 10.3 bar				
Replacement Filter Elements	DBB7733 Compact Fuel Filter	DBB8666 Fuel Filter & DBB0248 Water Absorbing Filter	DBB8777 Fuel Filter & DBB0248 Water Absorbing Filter	DBB8666 Fuel Filter & DBB0248 Water Absorbing Filter	DBB8777 Fuel Filter & DBB0248 Water Absorbing Filter

For complete protection

We recommend installing a T.R.A.P. Breather to keep airborne contamination and moisture from entering your tank. Always confirm the selected breather is suitable for application flow rates and tank specification. Select from one of the following;

Mobile Tanks

- P767025 - 1/2" BSP Anti-splash
- P766645 - 3/4" BSP Anti-splash
- P766646 - 1" BSP Anti-splash



Fixed Tanks to 1000 Litres

- P564669 - 1" NPT
- P565616 - Bayonet
- P506113 - T.R.A.P. Breather Assembly



Fixed Tanks over 1000 Litres

- P923075 - T.R.A.P. Breather Filter
- DFF0078 - T.R.A.P. Breather Assembly
- P506063 - Dual T.R.A.P. Breather Assembly



See page 13 for Parallel and Series Filtration Flow Paths

Clean Diesel & Oil Carts

Clean Diesel Carts are the perfect solution for fuel transfer and kidney loop applications.

We offer convenient portable packages which enable off-line filtration to supplement existing filtration to achieve system cleanliness. Use with fixed industrial or mobile equipment to achieve and maintain proper ISO cleanliness levels.



Bu.FS.S Bulk Fuel Service System



Bu.FS.S. 12V Bulk Fuel Service System



B.O.S.S. Bulk Oil Service System



B.O.S.S. Lite Bulk Oil Service System

Part Number	P506057	X011408	P506037	P506081
Replacement Filter Elements	DBB8666 Fuel Filter & DBB0248 Water Absorbing Filter		DBB8664 Oil Filter	P565183 Bulk hP Filter
Optional Filter Elements	DBB8777 Fuel Filter DBB7733 Compact Fuel Filter DBB5333 Compact Fuel Filter		DBB8665 Oil Filter & DBB0248 Water Absorbing Filter	P565184 Bulk hP Filter P565185 Bulk hP Filter
Target ISO Cleanliness	14/13/11 or better		18/16/13 or better	
Fluid Compatibility	All diesel fuels		Hydraulic, gear, transmission and engine oils	
Micron Rating & Efficiency	<4 micron @ Beta 2000		25 micron @ Beta 2000	14 micron @ Beta 2000
Water Absorbing Filter	For free and emulsified water (optional for P506037)			n/a
Power Consumption	240 Volt 50 Hz with 2m cable	12V 35 Amp max	240 Volt 50 Hz with 2m cable	240 Volt 50 Hz with 2m cable
Max. Flow Range	63 lpm @ 2800 RPM	57 lpm @ 2900 RPM	40 lpm @ 1450 RPM	6 lpm @ 1450 RPM
Pump	Vane pump	Vane pump	Gear pump	Gear pump
Dimensions	H=1300mm W = 550mm D = 700mm	H = 576mm W = 521mm D = 186mm	H = 1300mm W = 550mm D = 700mm	H = 430mm W = 435mm D = 155mm
Weight	65 Kgs	34 Kgs	65 Kgs	14 Kgs



Fuel and Lubricant Filters

Premium Donaldson Blue® Clean Solutions filters provide unsurpassed cleanliness in a single pass. They are suited to inlet and outlet filtration applications. Their spin-on design enables fast and simple filter changes without special tools and provides greater protection from contamination during service than traditional cartridge style filters.

Donaldson Blue bulk fluid filters incorporates our best technology and construction to handle all fuels and lubricants in all operating environments. Donaldson Electrostatic Reduction Tehchnology (D.E.R.T.™) prevents filter media damage from electrostatic discharge. Epoxy is used in filter construction for increased fluid compatibility. E-coating provides maximum corrosion resistance and epoxy adhesion. Viton® O-rings provide reliable sealing and maximum fluid compatibility

Viton® is a registered trademark of E.I. DuPont de Nemours and Company.



FEATURES

- Highly efficient, state-of-the-art filter media and design
- Unsurpassed filter efficiency
- Cleans to target ISO cleanliness in a single pass
- Modular design can be configured for virtually any flow rate or usage level
- Fast and easy to service

APPLICATIONS

- Single pass filtration for clean fluid transfers
- High efficiency kidney looping
- Inlet and outlet filtration at bulk storage tanks
- Dispenser "polishing" filtration on fuel pumps and hose reels
- Mobile and stationary applications

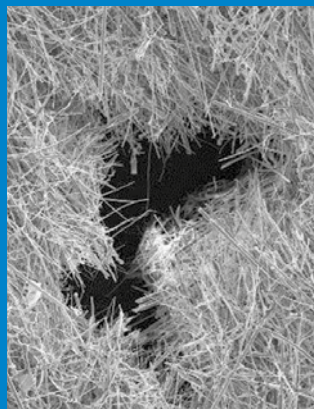

Filter media damage from Electrostatic Discharge (ESD).

D.E.R.T.™

Donaldson Electrostatic Reduction Technology

Electrostatic discharge can be created when diesel fuel or light oils pass through filter media at high flow rates.

The fluid being filtered may have inadequate conductivity to dissipate the charge generated by high flow filtration applications. The electrical charge can build-up in the fluid until it discharges or sparks across the filter, burning holes in the filter media and letting through harmful contaminants.

Donaldson's proprietary Electrostatic Reduction Technology neutralizes electrical charge and prevents damage to the filter media. This enables efficient single pass fuel filtration in high flow applications.



Part Number	DBB5333	DBB7733	DBB8666	DBB8777	DBB8665	DBB2533	DBB8664	DBB0248	
Single Pass ISO Cleanliness*	14/13/11	16/14/11	14/13/11	16/14/11		18/16/13		Not Applicable	
Efficiency	4 micron @ Beta 2000	7 micron @ Beta 2000	4 micron @ Beta 2000	7 micron @ Beta 2000		25 micron @ Beta 2000		Not Applicable	
Fluid Compatibility	All diesel fuels				Transmission and hydraulic oil		Engine and gear oil		Ethanol-free fluids
Recommended Viscosity Range	< 100 cSt				< 500 cSt		< 3000 cSt		< 1500 cSt
Working Pressure	350 psi / 2413 kPa / 24.1 bar								
Element Collapse Pressure	150 psi / 1034 kPa / 10.3 bar								
Rated Static Burst	800 psi / 5516 kPa / 55.2 bar								
Max. Flow Range**	121 lpm / 32 gpm		246 lpm / 65 gpm			121 lpm / 32 gpm		246 lpm / 65 gpm	
D.E.R.T.***	Yes				No				
Nominal Dimensions	119 mm OD (4.7") x 191 mm L (7.5")		119 mm OD (4.7") x 362 mm L (14.25")			119 mm OD (4.7") x 191 mm L (7.5")		119 mm OD (4.7") x 362 mm L (14.25")	
Operating Temperature	-40 to 245 °F / -40 to 118 °C								

*Select the proper filter by fluid type and OE recommended ISO code. Do not over-filter fluids. Doing so may result in the stripping of beneficial additives.

**Actual flow rate varies based on fluid viscosity, pumping pressure and filter loading.

***DERT™ Donaldson Electrostatic Reduction Technology prevents media damage during high flow fuel applications.

See pressure drop/flow rate charts on page 18-19.



Filter Heads

Clean Solutions filter heads feature robust, aluminium construction with steel inserts to minimize metal-to-metal galling between the head and the filter, even when used with diesel fuel.

The threaded insert contains an O-ring seal to completely seal the clean side of the filter from the dirty side for maximum single pass protection. Viton® seals are compatible with a wide range of fluids and maintain their integrity in cold weather.

For maximum cleanliness, use Clean Solutions filter heads with Donaldson Blue bulk fluid filters.

Viton® is a registered trademark of E.I. DuPont de Nemours and Company.



FEATURES

- Steel inserts are safe to use with diesel fuels
- Threads contain an O-ring to completely seal the clean side from the dirty side of the filter
- Heads are pre-ported for optional pressure gauges and service indicators

APPLICATIONS

- For use with Clean Solutions filters
- Compatible with all diesel fuels and lubricants

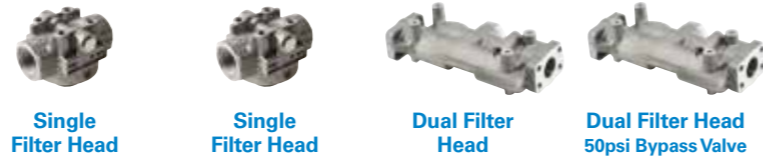

	Part Number	P570329	P570330	P568583	P574958
	Connection	SAE-20 O-ring	1 1/4" NPTF	1 1/2" SAE 4-Bolt Code 61 Flange	1 1/2" SAE 4-Bolt Code 61 Flange
	Filter Quantity*	1	1	2	2
	Max. Flow Range**	246 lpm / 65 gpm		473 lpm / 125 gpm	
	Fluid Compatibility	All diesel fuels and lubricants			
	Working Pressure	350 psi / 2413 kPa / 24.1 bar			
	Rated Static Burst	800 psi / 5516 kPa / 55.2 bar			
	Operating Temperature	-40 to 118 °C / -40 to 245 °F			
	Indicator Port	Use to adapt pressure gauges or sampling ports (sold separately see page 26-27)			
	Materials	Aluminium head with threaded steel inserts and Viton® seals			
	Compatible Filters	DBB5333, DBB7733, DBB8666, DBB8777, DBB8665, DBB2533, DBB8664, DBB0248			

*Filters sold separately
**Actual flow rate varies based on fluid viscosity, pumping pressure and filter loading.

Single Filter Head P570329 | P570330

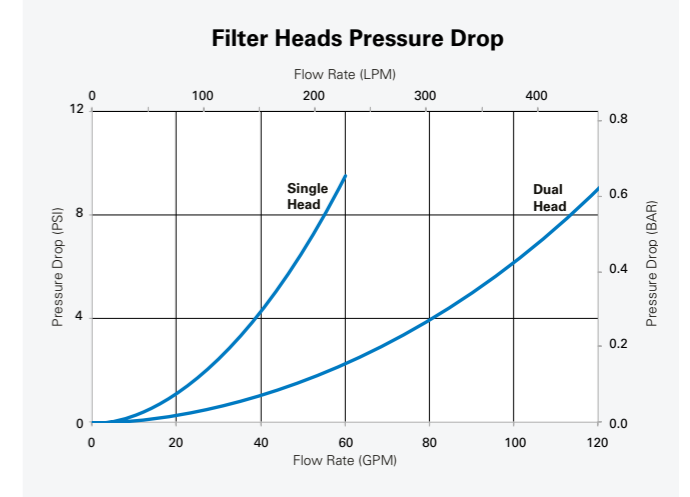
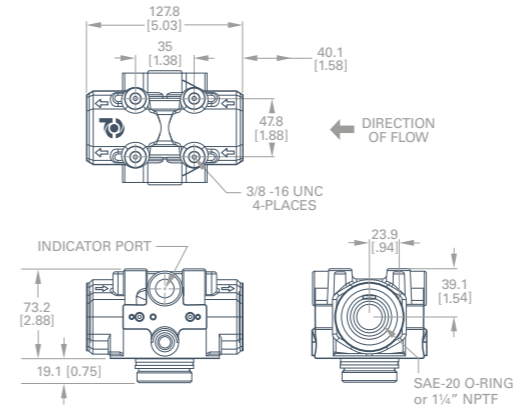

Dual Filter Head P568583 | P574958

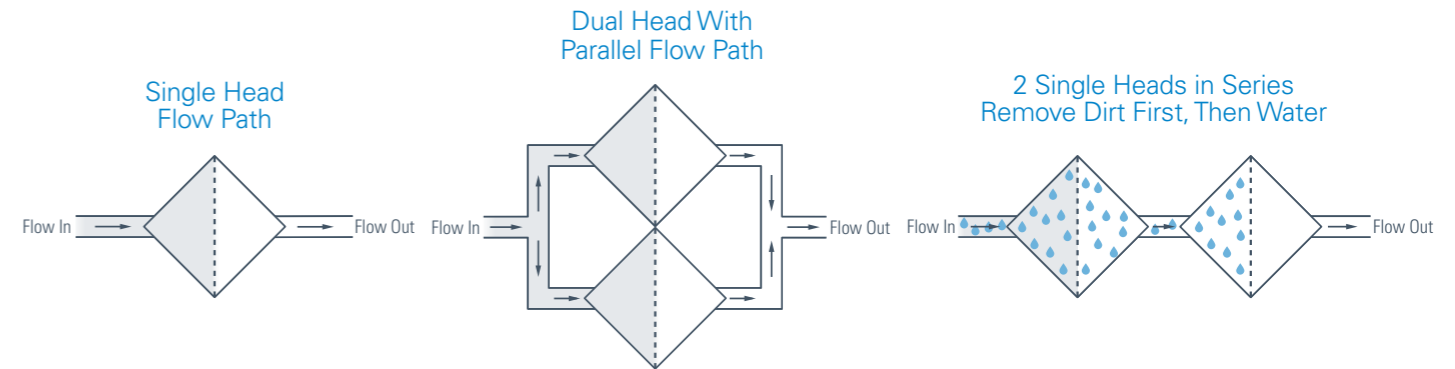
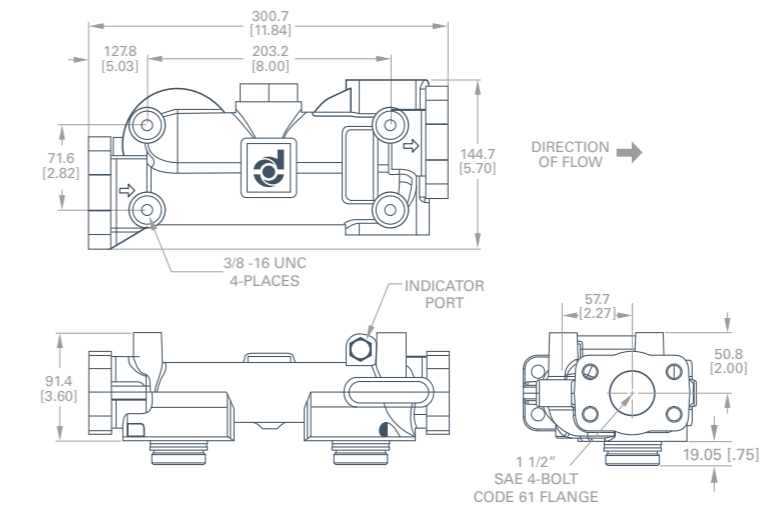



Manifolds

Clean Solutions Filter Manifolds expand capacity or increase flow rate beyond the capability of a single or dual filter head. Two or more manifolds can be plumbed together to accommodate even larger flow rates.

Manifolds split flow evenly between the individual filters. Fluid passes through only one of the filters on its way across the manifold. Dividing the flow between multiple filters plumbed in parallel reduces the pressure drop through each filter.

The combination of Clean Solutions manifolds and filters ensure that your equipment receives the cleanest possible fuel and oil.



Part Number	P561880	P568932	P568933	1KDFF1008	DFF1012
Filter Quantity**	4	8	10	Up to 8	Up to 12
Mounting Connection	2" ANSI 150 Flange		4" ANSI 150 Flange		
Max. Flow Range***	946 lpm / 250 gpm	1893 lpm / 500 gpm	2271 lpm / 600 gpm	1700 lpm / 450 gpm	2650 lpm / 700 gpm
Shipping Weight	64 kg / 140 lbs	141 kg / 310 lbs	177 kg / 390 lbs	46 kg / 102 lbs	58 kg / 128 lbs
Pressure Gauges	2 pcs 0-160 psi / 0-11 bar gauges included			Accessories Sold Separately	
Sampling	Includes up-stream and down-stream mini-mess sampling ports with M16 x 2 thread				
Fluid Compatibility	All diesel fuels and lubricants				
Working Pressure	260 psi / 1792 kPa / 17.9 bar up to 30°C / 100°F			145 psi / 1000 kPa / 10 bar	150 psi / 1034 kPa / 10.3 bar
Construction	Painted carbon steel pipe with aluminium heads			Painted carbon steel	
Compatible Filters	DBB5333, DBB7733, DBB8666, DBB8777, DBB8665, DBB2533, DBB8664, DBB0248				
Operating Temperature	-40 to 118 °C / -40 to 245 °F				

**Filters sold separately

***Actual flow rate varies based on fluid viscosity, pumping pressure and filter loading.

FEATURES

- Fast, easy and safe to service
- Requires no electrical or air hook-ups
- Large capacity in small footprint
- Flexible mounting options (horizontal or vertical)
- Cost effective high capacity system

APPLICATIONS

- Bulk fuel and lubricant filtration and water removal
- High flow transfer into or out of tanks and dispensing equipment
- Hard-to-filter high viscosity oils
- Inline industrial filtration of gear oils and lubricants
- Kidney loop applications

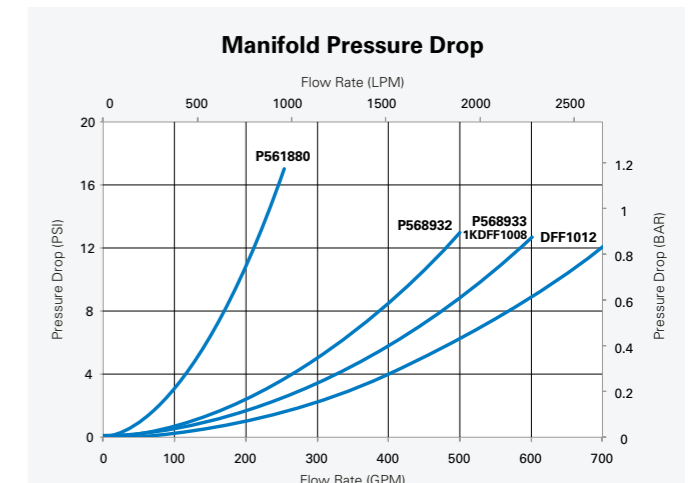
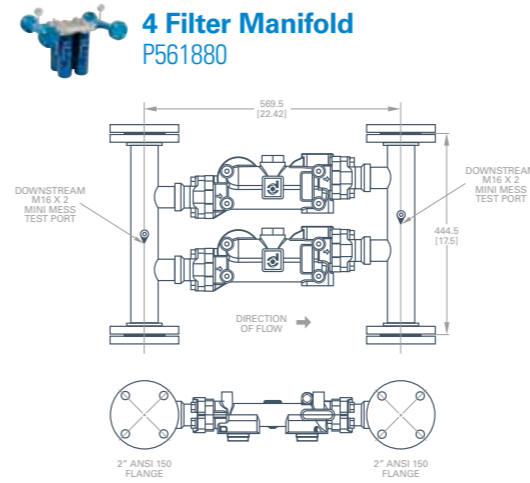

See system Sizing and Design on page 28-31 and pressure drop / flow rate curves on page 18-19.

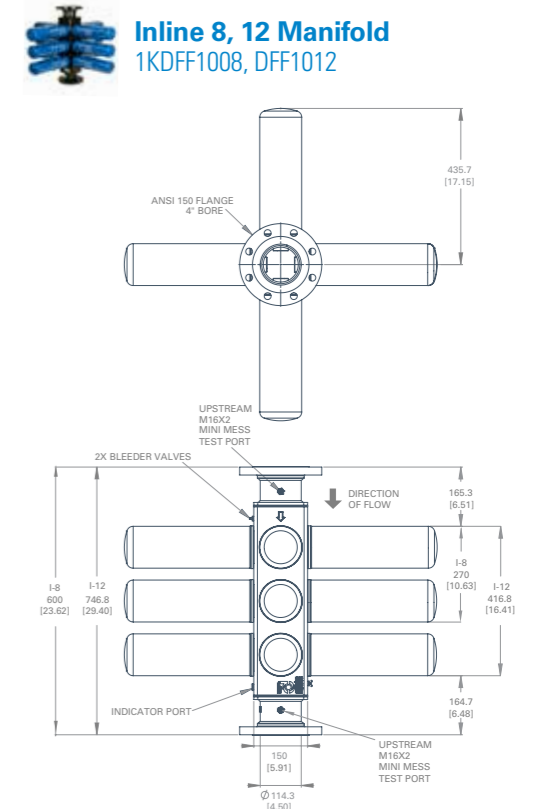
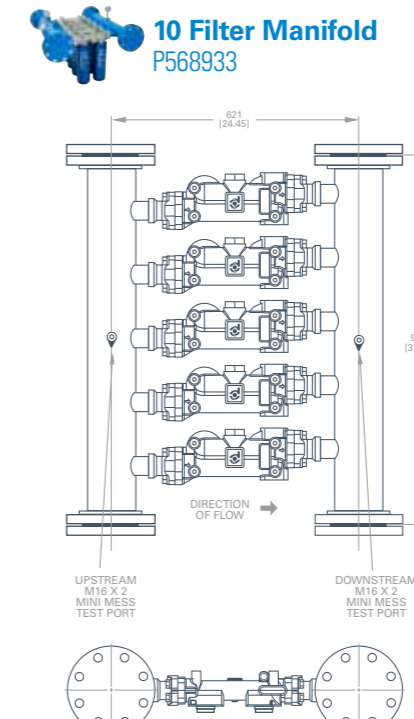
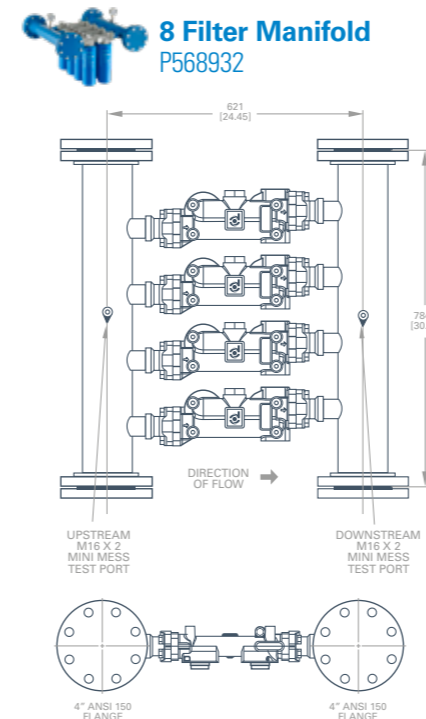

See page 26 for Blanking Caps and Other Accessories.



Bulk hP Filters and Heads

Filtering oil prior to dispensing into equipment is critical to meet the ISO cleanliness specifications demanded by today's OEM's. Donaldson Bulk hP filters provide high efficiency filtration in a single pass.

Service shops use high pressure pumps to force oil through long lengths of piping and hose reels prior to dispensing into equipment. Donaldson Bulk hP filters remove contaminants delivered in oil and picked up in storage or delivery lines during final transfer. They ensure the required ISO cleanliness level is met every time.



hP Single Head

hP Head with Bypass

Part Number	P566023	P566024
Working Pressure	1000 psi / 6894 kPa / 68.9 bar	
Indicator	Yes	
Bypass Valve	No	Yes - 50 psi / 345 kPa / 3.4 bar
Connections	SAE-16 O-ring	

Bulk hP Filter

Bulk hP Filter

Bulk hP Filter

Part Number	P565184	P565185	P565183
Target ISO Cleanliness	14/13/11	16/14/11	18/16/13
Fluid Compatibility	Petroleum based oils		
Max. Flow Range	189 lpm / 50 gpm		
Efficiency	4 micron @ Beta 2000	8 micron @ Beta 2000	14 micron @ Beta 2000
Working Pressure	1000 psi / 6894 kPa / 68.9 bar		
Element Collapse Pressure	300 psi / 2068 kPa / 20.7 bar		
Application	Hydraulic, gear, transmission and engine oils		
Rated Static Burst	2200 psi / 15,168 kPa / 151.7 bar		

FEATURES

- Up to 1000 psi / 6894 kPa / 68.9 bar working pressure
- Extended life filters with high dirt holding capacity
- Easy disposal with recyclable can and incinerable element
- Compact design requires only 1.5" / 38 mm clearance for servicing

Bulk hP Filter Heads
P566023 | P566024

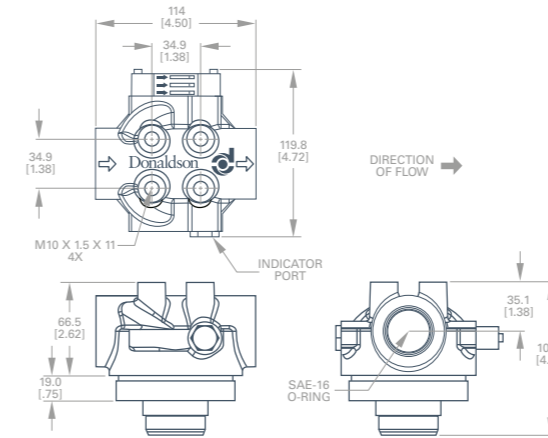

Bulk hP Filters
P565184 | P565185 | P565183

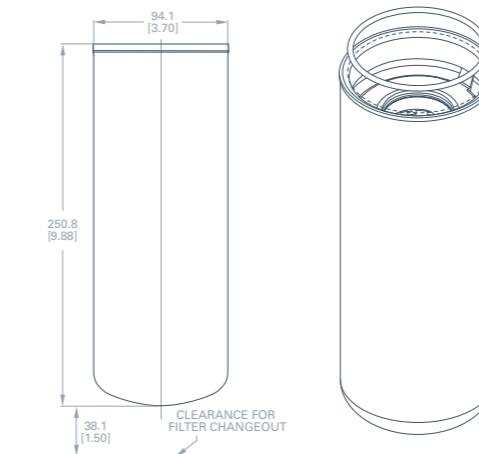

APPLICATIONS

- Lube shops
- Mobile service trucks
- Other higher pressure single pass applications

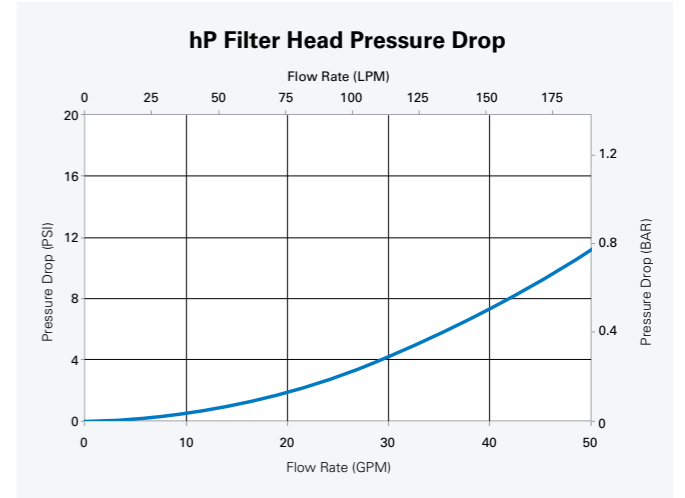

See system Sizing and Design on page 28-31 and pressure drop / flow rate curves on page 19.

WARNING

THERMAL EXPANSION Donaldson highly advises following the pump manufacturer's relief recommendations. Pump manufacturers offer relief valves to protect against over pressurization. A mere 5.5 °C / 10 °F increase in oil temp can add 450 psi / 3103 kPa / 31 bar to the system while the pump is shut off.



Flow Rates and Pressure Drops

FUEL AND WATER ABSORBING FILTERS

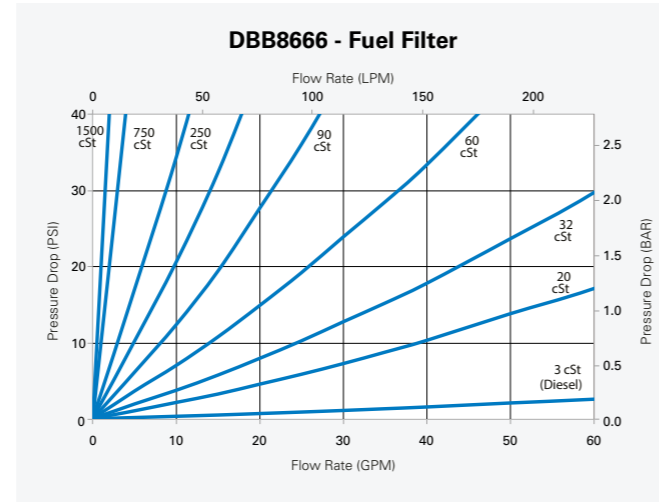
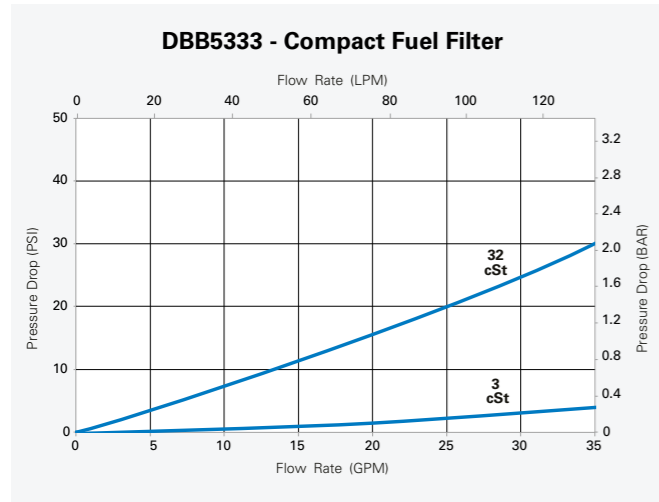

Flow Rates and Pressure Drops

LUBRICANT FILTERS

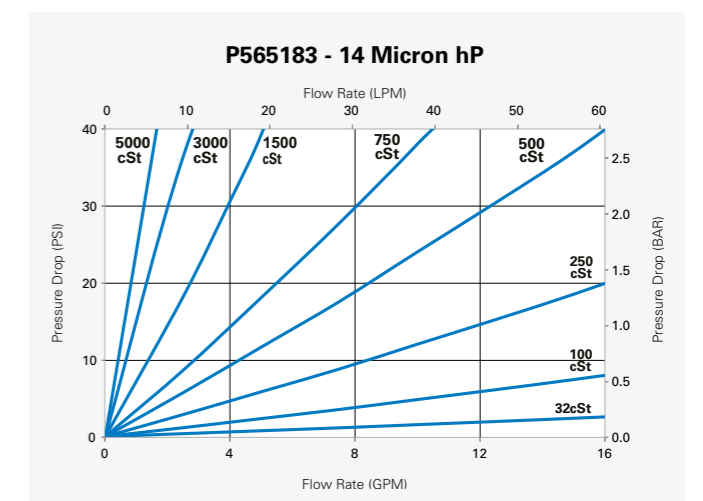
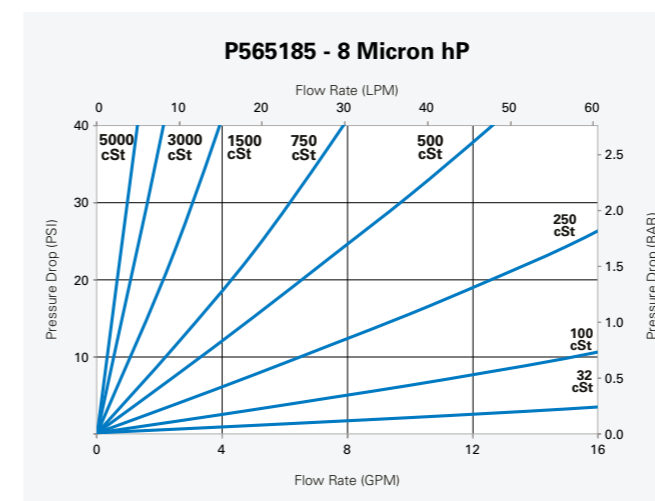
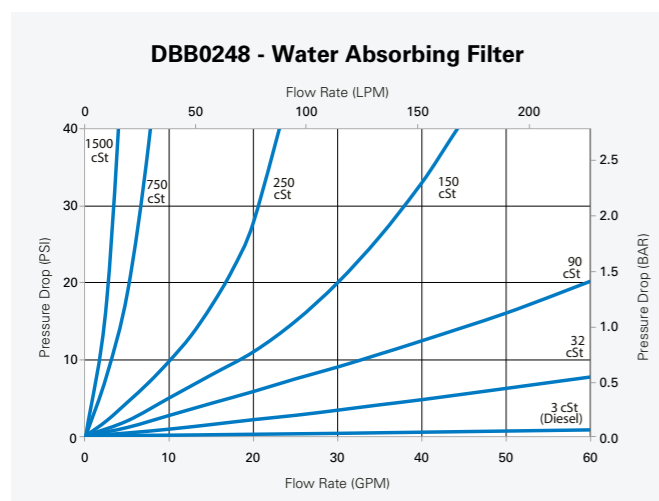
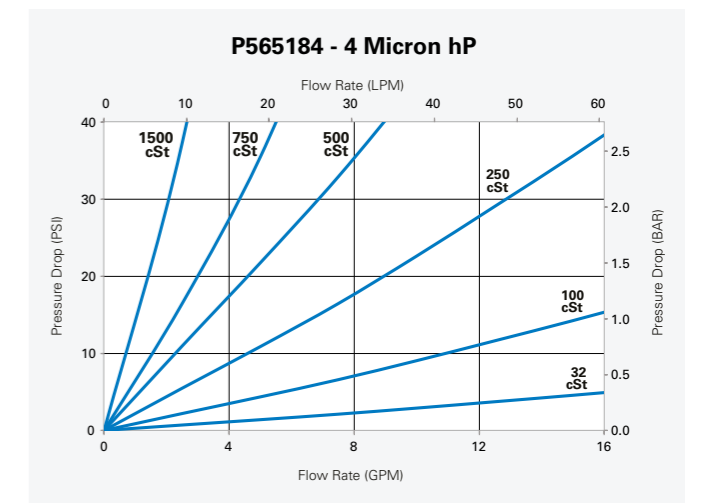
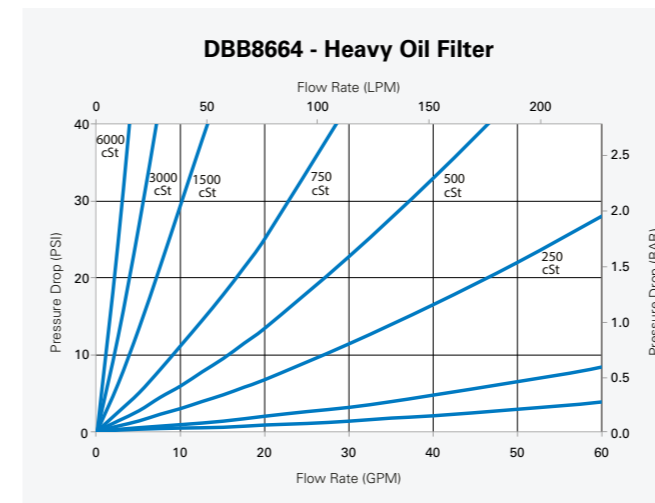
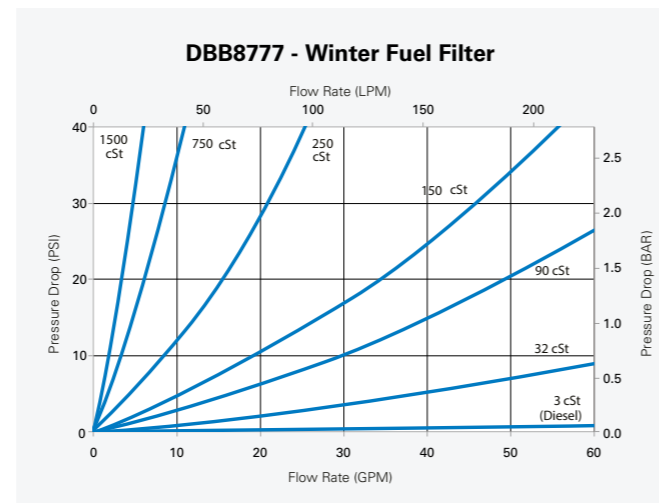
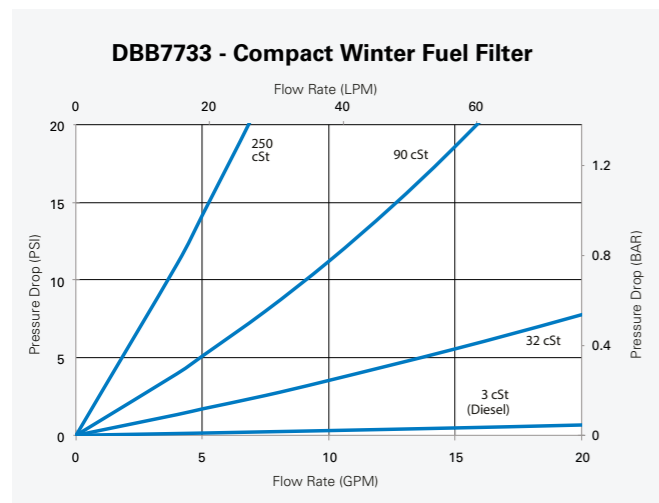
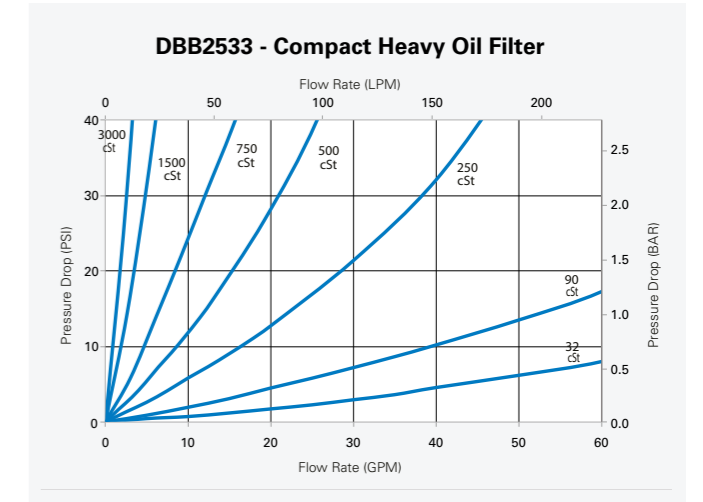
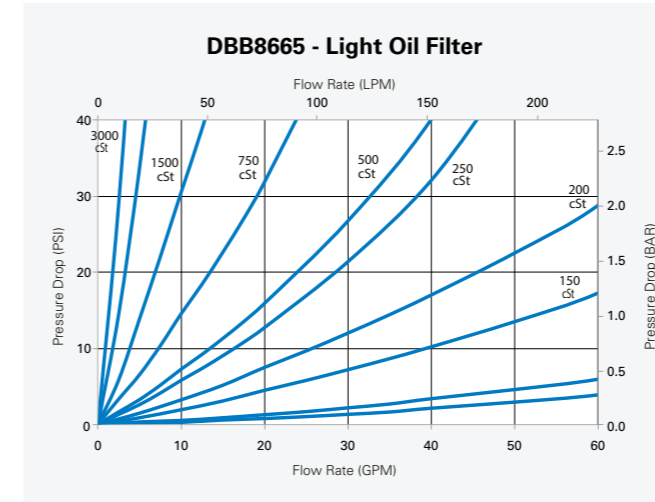

T.R.A.P.™ Breather Assemblies

The Thermally Reactive Advanced Protection (T.R.A.P.™) Breather assembly protects the fluids in your storage tank from airborne particulate moisture contamination and ambient moisture.

It combines a high capacity 3 micron air filter with a deliquescent breather and dries itself when air is expelled from the tank. This self-regenerating capability of T.R.A.P.™ enables extended life and functionality.

Keep your fluids clean and dry with a Donaldson T.R.A.P.™ Breather.

Tanks sizes above 37,854 l / 10,000 gal may require multiple units and pressure vacuum relief valves.

Contact Donaldson for assistance.



T.R.A.P. Breather



T.R.A.P. Breather



T.R.A.P. Pressure & Vacuum Breather Assembly



Dual T.R.A.P. Pressure & Vacuum Breather Assembly

Assembly Part Number	DFF0078	P506148	P506113	P506063
Efficiency	97% efficient @ 3 micron			
Max. Flow Range	For inlet or outlet flow up to 500 lpm maximum			For inlet or outlet flow up to 1,000 lpm
Overflow Check Valve	Opens at 2.32 psi / 15 kPa	3 psi / 20.7 kPa	N/A	N/A
Standard PV Settings	N/A	N/A	3.1" H ₂ O Vacuum and 6.7" H ₂ O Pressure	
Compliance	N/A	N/A	API2000	
Operating Temperature	-40 to 200 °F / -40 to 93 °C			
Fluid Compatibility	Safe for use with all fuels and lubricants			
Indicator	Standard mechanical		12450-400 Magnahelic gauge	
Height	410 mm / 16"		520 mm / 23.5"	656 mm / 25.8"
Construction	ABS housing, Urethane end caps, brass	ABS housing, Urethane end caps, stainless steel	ABS, Urethane, Aluminium, Steel, Brass	
Connection	1 1/2" BSP female	1 1/2" BSP female	2" BSPT socket	
Replacement filter	P923075 x 1			P923075 x 2

FEATURES

- High efficiency air filtration
- Longer life and lower airflow restriction than typical silica gel breathers
- Self-regenerating moisture adsorption
- Easy to service

APPLICATIONS

- For use with all diesel fuels and lubricants
- Above and below ground tanks
- Mobile service trucks
- Indoor or outdoor applications
- Most tanks up to 37,854 litres / 10,000 gal. (large tanks may require multiple units)

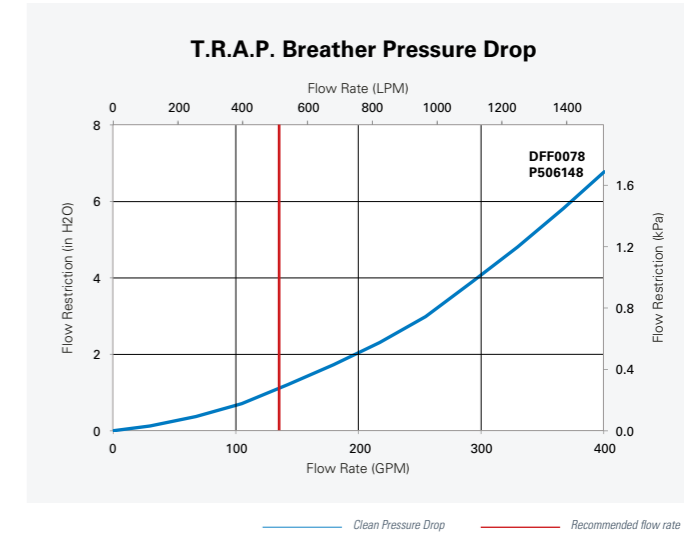
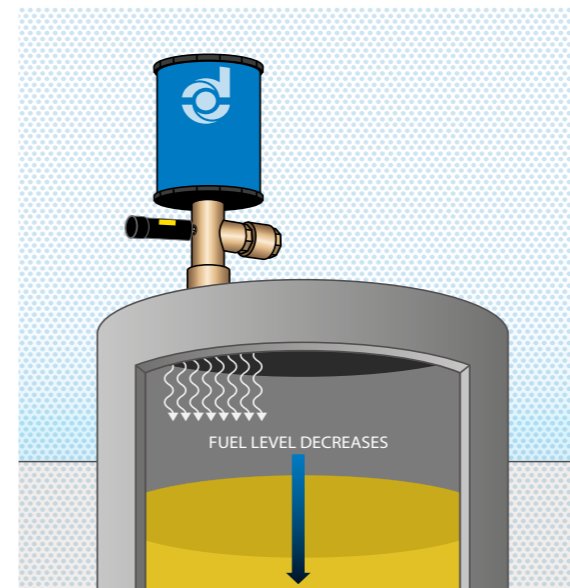
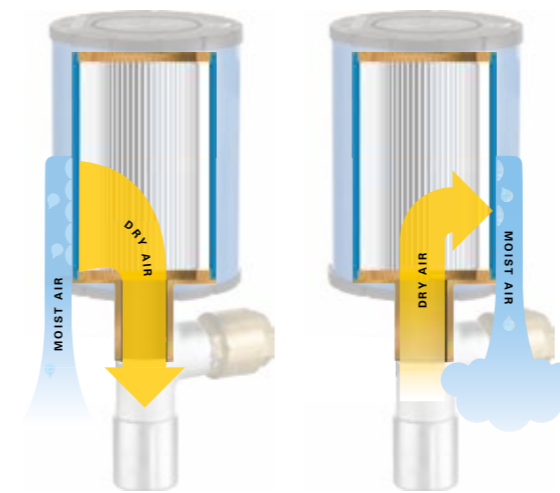

T.R.A.P. Breather
DFF0078 & P506148

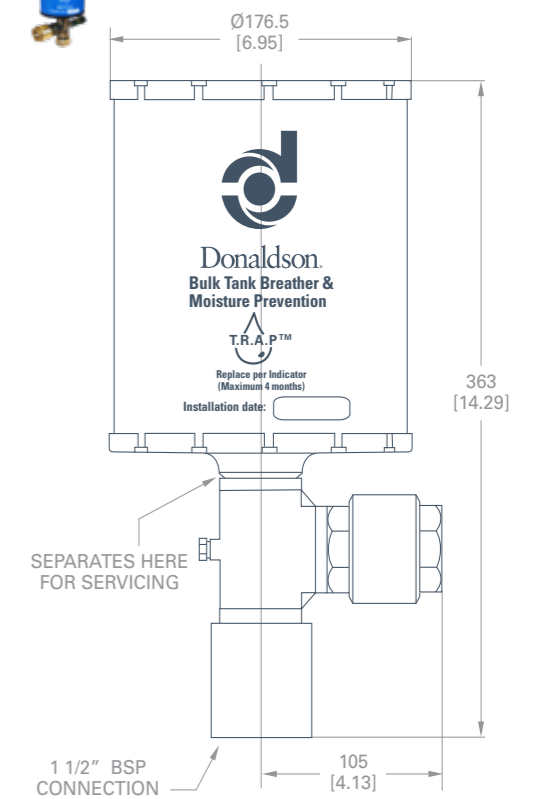

WARNING

Always locate your tank's name plate and cross check against the flow chart above to ensure safety. Use maximum flow INTO tank for validating pressure rating and flow OUT OF tank for vacuum ratings. DO NOT EXCEED TANKS SAFE PRESSURE OR VACUUM.



Flow Rates and Pressure Drops

T.R.A.P. BREATHER PRESSURE & VACUUM BREATHER ASSEMBLIES

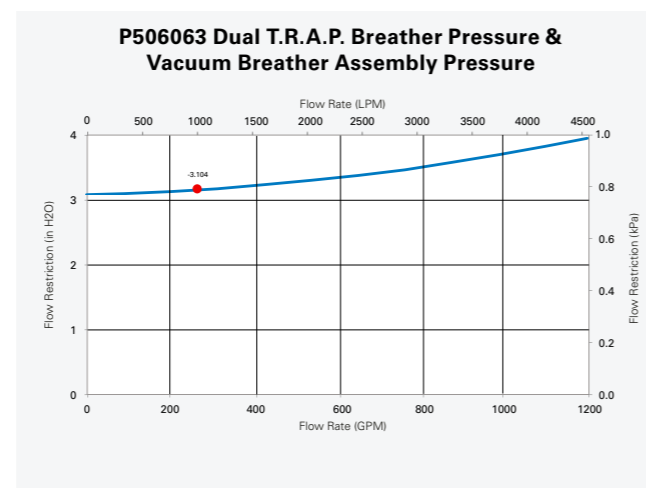
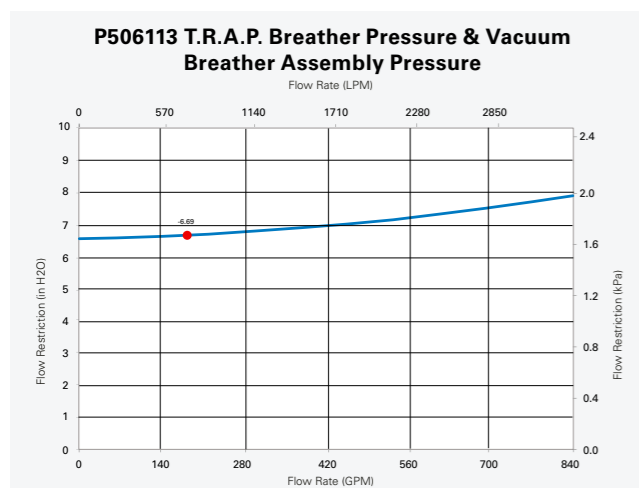
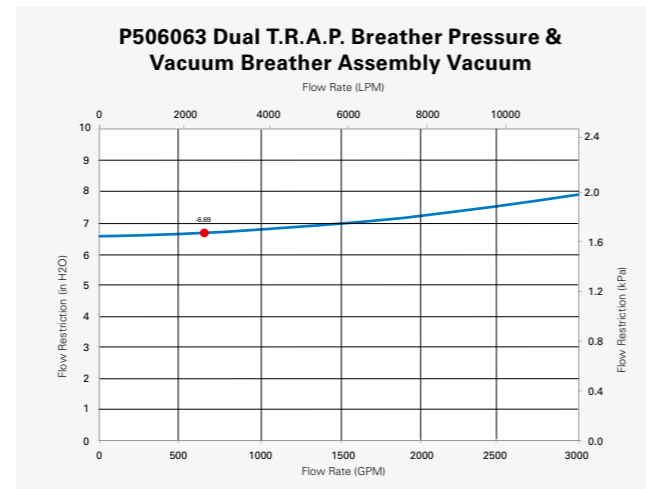
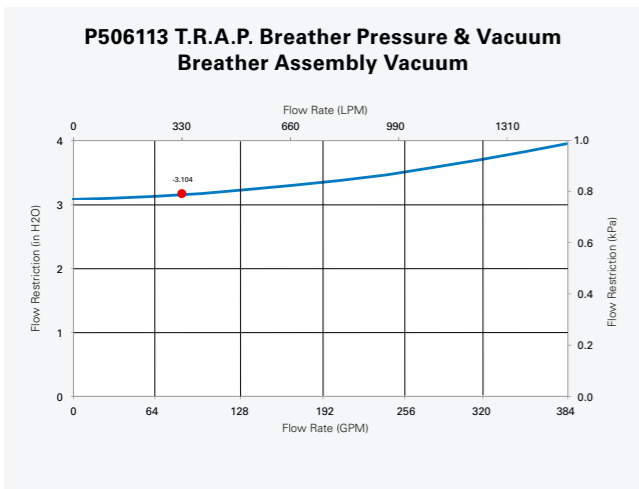
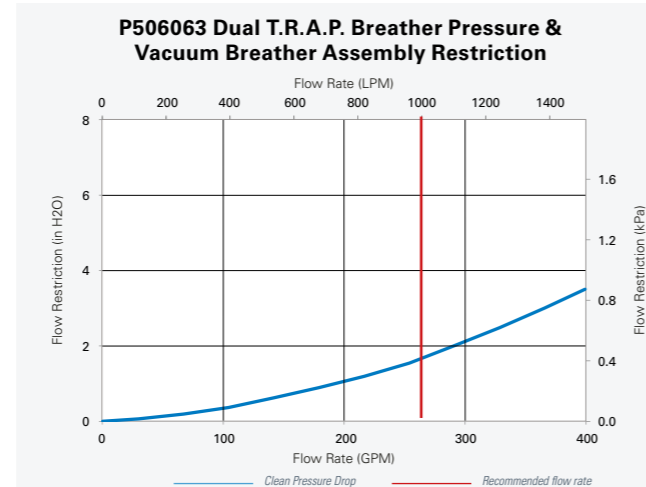
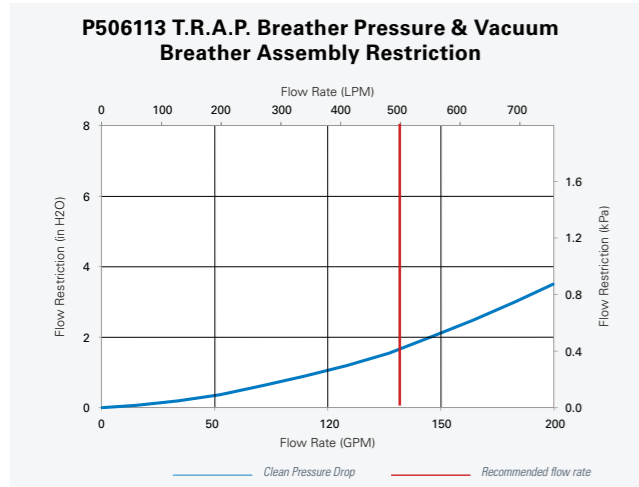

Reservoir Air Dryer

The Donaldson Reservoir Air Dryer eliminates the need to continually replace conventional desiccant breathers, enhancing reservoir breathing systems by continuously purging and dehydrating reservoir headspace.

With no electrical requirements, the Donaldson Reservoir Air Dryer combats atmospheric ingress of moisture by introducing a steady stream of clean, dry air to the reservoir. This constant airflow helps sustain optimal conditions and prevents the formation of condensation and rust in the reservoir, minimizing the potential for particulate and water ingress through reservoir access points.

When combined with a T.R.A.P. Breather, the complete system keeps moisture and contamination out, even if fluid flow rate out of the tank surpasses the Reservoir Air Dryer flow rate into the tank.

FEATURES

- The clean, dry air sweep dehydrates the reservoir head space and removes dissolved moisture from exposed oils and fuel
- Operates with standard plant air; instrument quality air is not required.
- Submicron coalescing air filter collects oil and water and fine particles present in the air
- Automatic drain purges captured liquid with no intervention required
- Visual indicator monitors filter condition
- Membrane air dryer reduces plant air dew point by as much as 83°C / 150°F
- Pressure regulator depressurizes the air and ensures that the proper flow rate of air is introduced into the reservoir



APPLICATIONS

- Lubricant system reservoirs
- Diesel storage tanks
- Oil storage tanks
- Gear boxes
- Hydraulic system reservoirs

Reservoir Air Dryer

Assembly Part Number	P575852
Efficiency	Reduces dew point as much as 150 °F (83 °C)
Outlet Flow Volume @ 100 psi and dew point suppression	0.5 scfm (14.2 slpm) maximum
Inlet Air required @ 100 psi	0.8 scfm (22.7 slpm) maximum
Pre-Filter Condition	Visual Indicator (Green/Red)
Pressure Regulator	Dial Gauge
Coalescer Drain	Automatic Float Type
Max Working Pressure	116 psi (800 kPa / 8.00 bar)
Max Operating Temperature	125°F (52°C)
Fluid Compatibility	Petroleum and Phosphate Ester Fluids, Diesel Fuels*
Inlet/Outlet Connection	¼" NPT
Mounting Bracket	3/8" - 16 UN Threaded Nut
Weight	<5 lbs (<3 kgs)
Replacement	Coalescing Pre-Filter

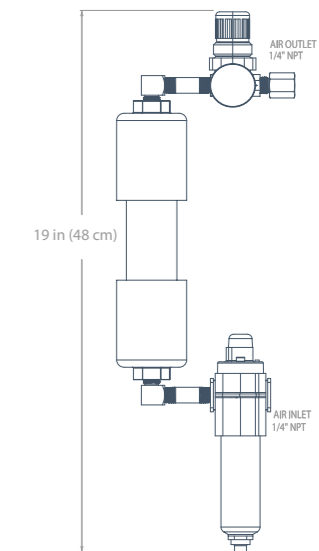
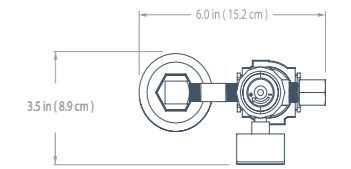

*The Reservoir Air Dryer is not recommended for use on gasoline holding tanks or for the head space of any flammable liquid (Flash Point of 100F/38C)



Clean DEF Filter

Today's Selective Catalytic Reduction (SCR) emissions control systems require clean Diesel Exhaust Fluid (DEF) for precise dosing and complete atomization to occur. However, contamination from transfer and storage or corrosion from incompatible materials can prevent your SCR system from getting the clean DEF it needs for proper operation.

The Donaldson DEF filter catches contaminants before they reach your vehicle or equipment and the onboard DEF filter. Clean DEF ensures proper function of the SCR and extends the life of the onboard DEF filter.

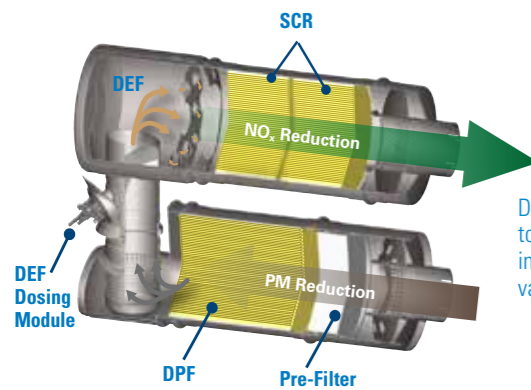

DEF must be clean for proper dosing to occur and turn NOx from exhaust into harmless nitrogen and water vapor.



PART NUMBERS

- P575058 DEF Filter Housing 1" BSPT
- P575059 Clean DEF Filter
- P575060 DEF Housing Replacement O-ring

MOUNTING BRACKET



DEF Filter Housing P575058

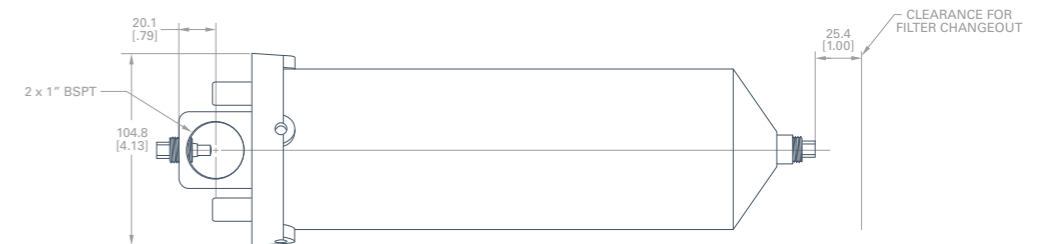
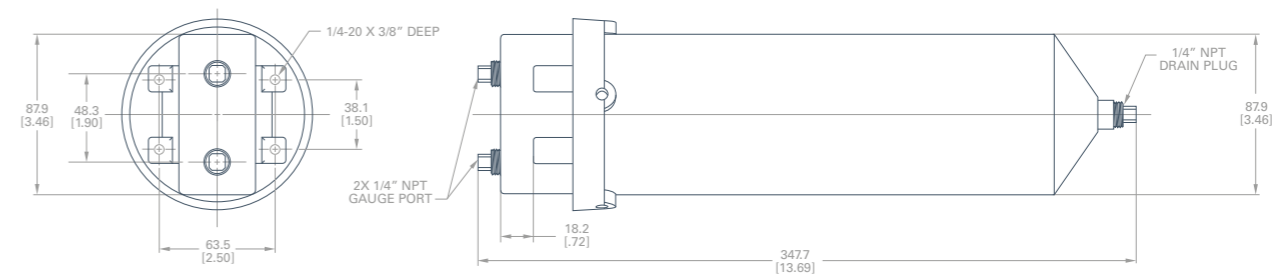

Stainless steel pressure gauge not included – must be sourced separately.

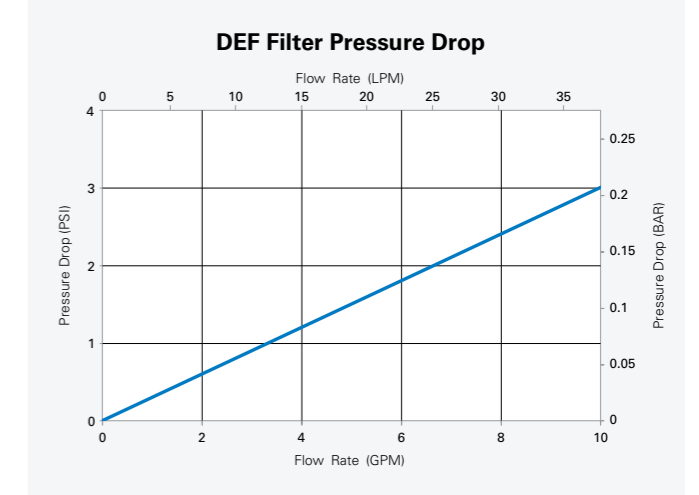

FEATURES

- 1 micron at beta 5000 efficiency
- 316 stainless steel housing
- Precise knife edge internal seal
- Heavy duty construction
- Maximum working pressure of 300 psi
- Leak-free O-ring seal
- Integrated gauge/sample ports
- Replacement filters available individually

APPLICATIONS

- DEF dispensers up to 38 lpm / 10 GPM



DEF Filter	
DEF Filter Housing	P575058 1" BSPT Housing includes mounting bracket and filter wrench
DEF Filter Element	P575059 sold separately
DEF Housing O-ring	P575060 replacement part
Micron Rating & Efficiency	1 micron @ Beta 5000 (99.98%)
Max. Flow Range	10 gpm / 38 lpm
Working Pressure	300 psi / 2068 kPa / 20.7 bar
Operating Temperature	12 to 122 °F / -11 to 50 C°
Housing Construction	316 stainless, EPR O-ring
Filter Material	Polypropylene, EPDM gaskets
Indicator Port	¼" NPT, upstream and downstream
Drain Plug	¼" NPT

CAUTION

DEF IS HIGHLY CORROSIVE. All pipe fittings must be compatible with DEF. Most plastics as well as stainless steel are acceptable. Carbon steel, zinc, aluminium, brass, copper, etc. are not recommended due to undesirable chemical reactions. If any of these materials are used in your system they should be immediately replaced with a compatible material.



Accessories

PARTS

Part Number	Description	Application
DFF1005	I-8, I-12 Blanking Cap	Blank off up to 6 orifices on I-12 manifold for flush mounting
P506070	Commissioning Cap	Allow unfiltered flow through manifolds during site commissioning
P506071	4-Bolt Code 61 Flange to 1½" BSPP Adapter ¼" BSP, ¼" NPT ports (plugged)	Adapts P568583, P574958 Dual Head to 1½" BSPP
P506101	4-Bolt Code 61 Flange to 1½" BSPP Flange Connection Kit	Use with 1 x P506071 Flange to connect two dual heads in series
P573642	Threaded Pipe Nipple	1¼" NPT, for connecting two P570330 single heads in series
P164050	Threaded Insert O-rings	Replacement O-rings for heads and manifolds, Viton, not for use on hP
P506076	SAE 20 O-ring to 1" BSPT Male	Adapts P570329 Single filter head to 1" BSPT male
P506112	Pressure & Vacuum Valve 2"	Use with 1 x P923075 T.R.A.P. Breather or P506113 Single T.R.A.P. Breather Assembly
P506091	Pressure & Vacuum Valve 3"	Use with 2 x P923075 T.R.A.P. Breathers P506063 Dual T.R.A.P. Breather Assembly

PRESSURE GAUGES AND SERVICE INDICATORS

Part Number	Description	Application
P174396	Electrical Service Indicator 50 psi / 345 kPa / 3.45 bar	Use with all Clean Solutions heads and manifolds, microprocessor compatible
P574177	Visual Service Indicator 50 psi / 345 kPa / 3.45 bar	For single heads and hP heads, industrial grade green to red
P165965	Visual Service Indicator 25 psi / 172 kPa / 1.72 bar	For single heads and hP heads, industrial grade green to red
X220074	Remote Mount Visual Indicator Kit 4" H ₂ O / 0.14 PSI, 1kPa, connection 1/8" NPT or 3mm ID Hose, Bracket Mount	For use with DFF0078 T.R.A.P. Breather Assemblies
X220097	Remote Mount Visual Indicator	For use with P506148 T.R.A.P. Breather Assemblies
P639453	Visual Service Indicator Connector M10 x 1.5 - 15.5 mm ID	For use with X220097 Indicator

Part Number	Description	Application
P562709	Pressure Gauge, 0-160 psi / 1103 kPa / 11.0 bar	For Clean Solutions manifolds, stem mount, 2½" diameter, use with P563809 adapter
P573681	Pressure Gauge, 0 - 60 psi / 414 kPa / 4.1 bar	For single and dual heads, ⅛" NPT, center back mount, 42mm diameter, use with P573682 adapter
P573682	Upstream Pressure Gauge Adapter	For single and dual heads, ⅛" NPT
P563809	Direct Gauge Adapter	For Clean Solutions manifolds, M16 x 2 to ¼" NPT adapter, use to mount pressure gauge to test point

SAMPLING TOOLS

Part Number	Description	Application
P573414	Upstream Sampling/Indicator Port Adapter	For single, dual heads, and hP heads, SAE-4, use with P563224 for sampling
P573415	Downstream Sampling/Indicator Port Adapter	For single, dual heads, and hP heads, SAE-4, use with P563224 for sampling
P563224	Test Point	For use with P573414 and P573415 adapters SAE-4 to M16 x 2
P563212	Test Point	For all Clean Solutions manifolds, ⅛" NPT to M16 x 2
P563215	Test Point	For dual heads, ¼ BSPP to M16 x 2, use with P506071 flange, P506037 B.O.S.S. and P506057 Bu.F.S.S.
P563255	Test Point Hose Assembly, 1220mm	1620 series M16 x 2 thread, for use with P563212, P563215 and P563224 mini mess test points

TEST KIT

Part Number	Description	Application
X009329	Patch Test Kit	Test kit for measuring fluid cleanliness
P567869	0.8 Micron Membrane Filter	Spares for Patch Test Kit, purchase in multiples of 100
P567860	Solvent Dispensing Filter	Spares for Patch Test Kit, purchase in multiples of 1
P567865	Analysis Cards	Spares for Patch Test Kit, purchase in multiples of 50
P567861	120 ml Sample Bottle	Spare for Patch Test Kit



Bulk filtration systems must be designed properly to meet the desired ISO cleanliness code while maintaining the existing flow rates. The filter type and quantity of filters varies based on the desired cleanliness, system pressure and flow rate.

Increasing the **flow rate** will increase the pressure drop across a filter. If the pressure drop is too high, system flow rate can be reduced or damage to the filter can occur. To reduce the pressure drop, increase the number of filters in the system.

The chart below demonstrates the **pressure drop** experienced by a filter with various viscosities and flow rates. The steeper the pressure drop curve, the more filters that must be added to the system.

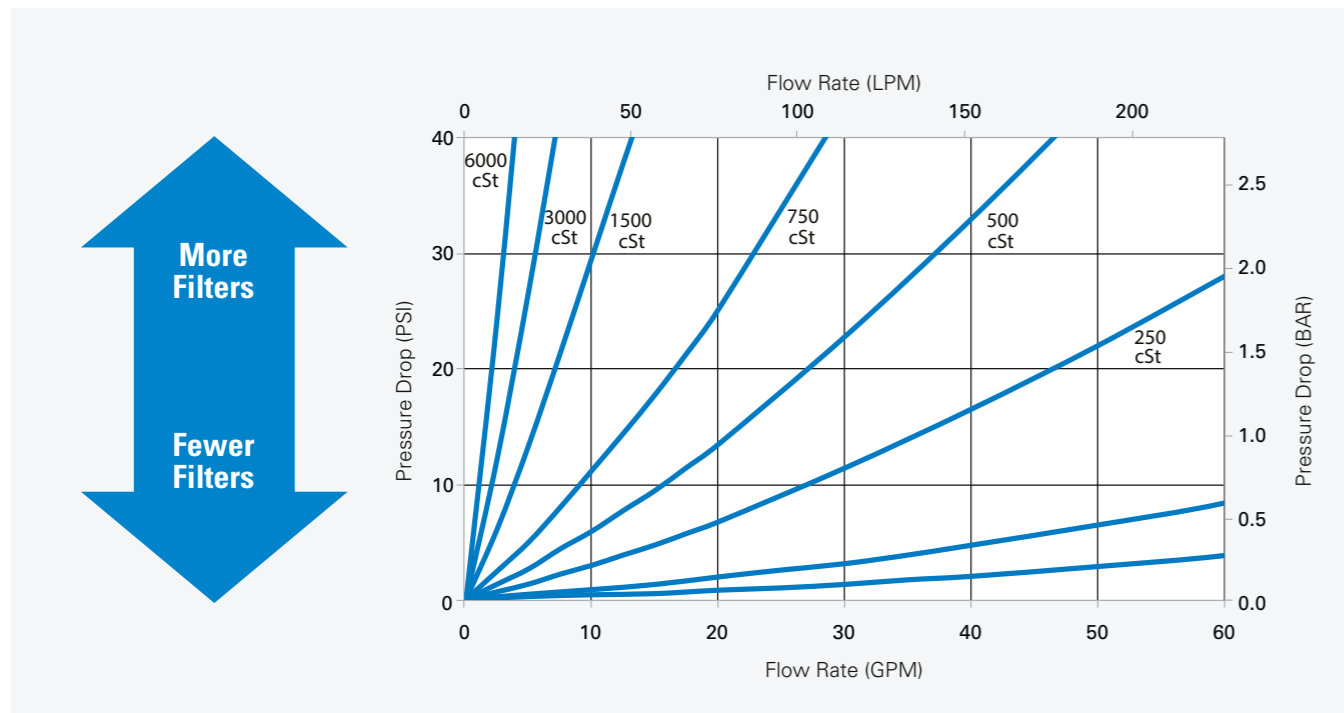
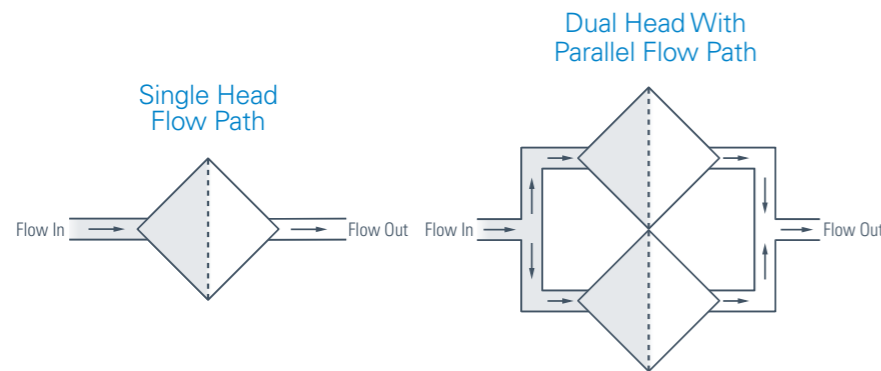

Additional filters plumbed in parallel will decrease the flow rate per filter, lowering the pressure drop and allowing existing flow rates to be maintained.

The Importance of Temperature in Sizing Your Filtration System

Fluid viscosity, measured in centistokes (cSt) or Saybolt Seconds Universal (SSU or SUS), is the resistance of a fluid to flow (thickness of fluid). Low viscosity fluids pass through filters with less resistance than high viscosity fluids. Higher fluid viscosities have higher pressure drops due to greater resistance passing through the media.

The colder the fluid, the higher the viscosity, so the lowest potential temperature of the fluid during filtration is the best measure for sizing a bulk filtration system. Due to the high specific heat capacity of fluids, the lowest ambient temperature may not be an accurate reflection of the actual fluid temperature. Avoid oversizing your system by using the stored fluid temperature and not the lowest ambient temperature, which tends to be lower than the temperature of the fluid in storage or transport.



WATER **HONEY**

Temperature greatly impacts fluid viscosity. Consider that ISO 32 oil at 40 °C / 104 °F has the same viscosity as diesel fuel (similar to water). When temperatures drop to -20 °C / -4 °F, the viscosity of that ISO 32 oil increases dramatically to over 2,000 centistokes, which is similar to honey at room temperature.

FUEL/OIL KINEMATIC VISCOSITY COMBINED WITH TEMPERATURE IN CENTISTOKES CST

SAE Gear Oil	75W		80W	85W	90		140						
SAE Engine Oil	5W	10W	20		30	40	50						
ISO Grade	15	22	32	46	68	100	150	220	320	460	680		
°F	°C		Diesel										
248	120			4	4	6	7	9	12	13	18	23	
230	110			4	6	7	9	12	15	19	24	30	
212	100		1	5	5	7	9	11	15	19	25	32	41
194	90		3	5	7	9	11	15	20	26	34	44	58
176	80		5	7	9	11	15	20	27	36	48	63	85
158	70		6	9	11	15	20	28	39	52	71	95	130
140	60		8	12	15	21	29	40	57	80	110	151	211
122	50		11	15	22	30	43	62	99	128	181	254	365
104	40	1	15	22	32	46	68	100	150	220	320	460	680
86	30	2	21	32	51	76	116	175	271	409	613	907	1,380
68	20	3	33	51	87	135	214	334	536	838	1,290	1,980	3,130
50	10	4	52	87	162	264	438	711	1,190	1,920	3,070	4,870	8,020
32	0	5	85	180	340	585	1,020	1,720	2,990	5,060	8,400	13,900	23,900
14	-10	9	185	375	820	1,500	2,770	4,880	8,890	15,700	27,200	47,000	85,000
-4	-20	15	400	800	2,350	4,650	91,20	16,800	32,300	60,000			



Steps to Sizing a Bulk Application

1 Define product flow rate, fluid type and pressure drop restriction. New systems should ideally have less than 10 psi / .69 bar pressure drop for fuel and 15 psi / 1 bar pressure drop for lubricants.

INFORMATION GATHERING

FLOW RATE: _____

FLUID TYPE: _____

PRESSURE DROP: _____

TEMPERATURE: _____

2 Use the table on the page 29 to determine fluid viscosity using the fluid type and temperature.

3 Select the appropriate filter based on desired ISO cleanliness code and working pressure (see pages 10 and 11).

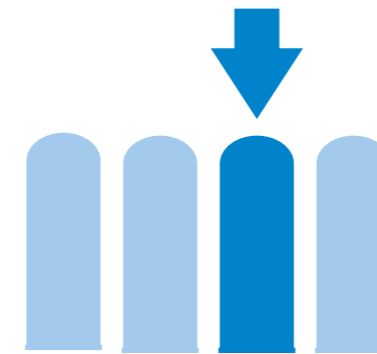

4 Determine the filter pressure drop using the flow rate and the fluid viscosity according to the appropriate chart on pages 18 – 19. Add the manifold pressure drop using the flow rate on page 15 to calculate total pressure drop.

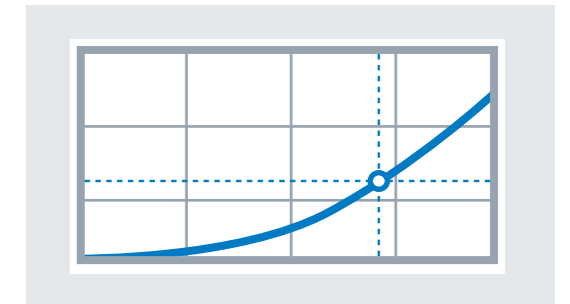

You Don't Need To Do It Alone.

Let a Donaldson specialist assist you by providing recommendations on sizing, selection and positioning of Donaldson filters. You can help us design your system by providing:

Responses to steps 1-4 above.

A schematic of your fluid transfer process (hand sketches work great), and/or

Photographs of your site (tanks, inlets and outlets).

Just call 1800 FILTER (345 837) to get started.

Divide total pressure drop through one filter by the desired system pressure drop. This number is equal to the quantity of filters required to clean the fluid properly at the determined flow rate. If the pressure drop is more than 10 psi / 0.69 bar pressure drop for fuel and 15 psi / 1 bar pressure drop for lubricants, increase filter assembly size.

$$\frac{\text{CALCULATED PRESSURE DROP}}{\text{DESIRED PRESSURE DROP}} = \text{[Number of Filters]}$$

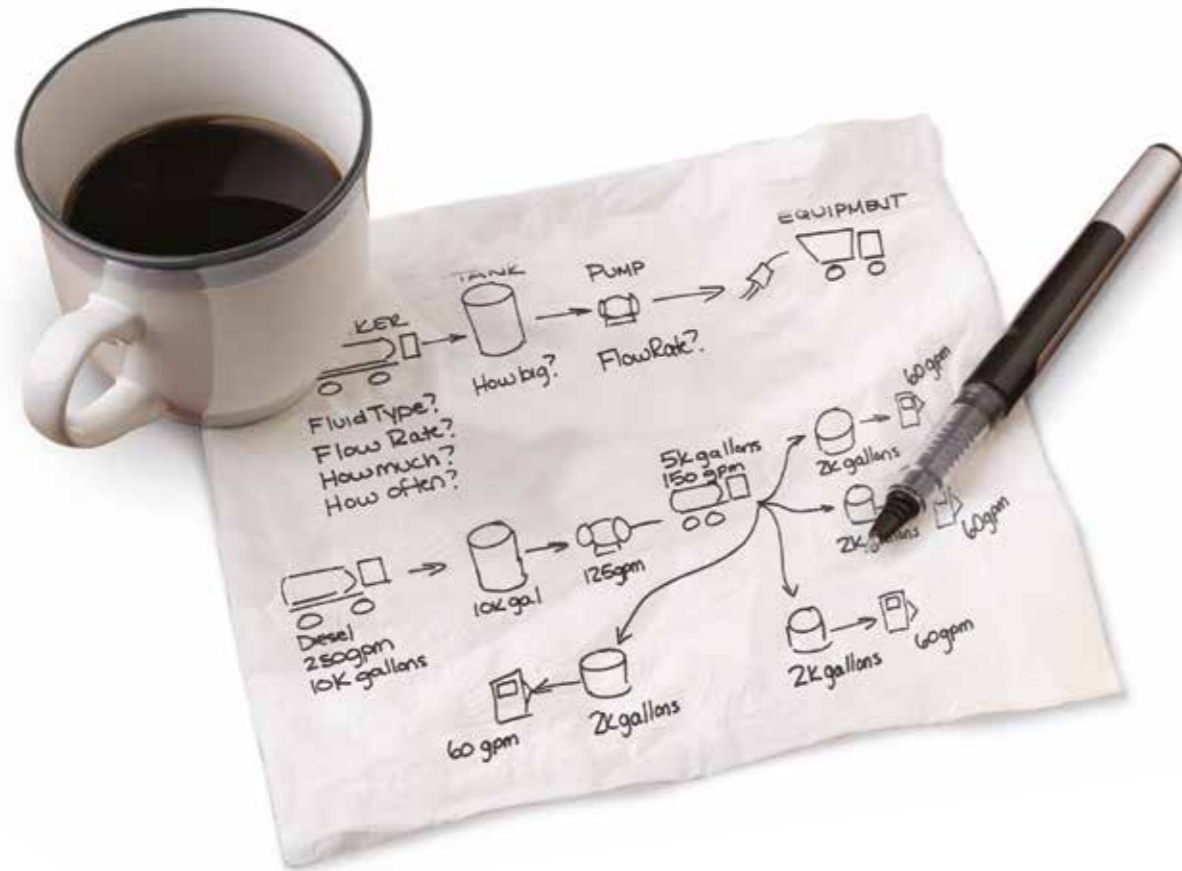



Global Presence with a Local Touch

At Donaldson, we've built a strong, flexible and responsive distribution network to serve our customers around the world.

Localized Manufacturing – It starts with 30+ manufacturing locations around the world – producing most filters in the regions where they're used.

Primary Distribution Centers – Filters then move to our regional warehouses and distribution center hubs – meaning the filters you need are never far away.

Logistics – We work with a network of transportation and logistics companies, consolidators and cross-docking facilities to deliver products to distribution partners quickly and efficiently.

Distribution Partners – We've built one of the largest, strongest and most responsive distributor networks in the filter industry – meaning you can find the filters and support you need, nearly anywhere in the world.



Donaldson Australasia Pty Ltd
Wyong, NSW, 2259

1800 FILTER (Australia)
+64 9 579 2790 (NZ)

MyCleanDiesel.com
donaldson.com.au

Need a Clean Solution?

As a global organization, we have offices throughout the world. Please direct your inquiry to clean.solutions@donaldson.com. This will enable us to address your inquiry in the shortest possible time.

USA/Canada	Caribbean	South Africa	Japan
Mexico	Brazil	South East Asia	Korea
Latin America	Europe & Middle East	Greater China	India

Brochure No. F111500 ENG AU (09/23)

© 2023 Donaldson Company, Inc. All rights reserved. Donaldson Company, Inc. reserves the right to change or discontinue any model or specification at any time and without notice. Printed in Australia.