

## Superior Protection for Larger Engines

### RadialSeal™ Sealing Technology Means Reliable Filtration and Quicker Service

The Donaldson two-stage FRG RadialSeal™ air cleaners provide improved reliability, better durability and reduced weight compared to axial seal style air cleaner designs. Choose from more than 20 air cleaners that work in airflow ranges of 82 to 1600 cfm.

### Two-Stage Filtration

Both Style A and B have an integral pre-cleaning stage that separates up to 85% of the incoming dust. The primary filter stops the rest, resulting in engine air that is 99.99% free of dust.

**Try PowerPleat™ for 11" Style B and 13" Style B. See page 65.**



*Donaldson FRG Air Cleaners and Duramax hydraulics filters deliver superior filtration to pump-and-engine rigs used in the oil and gas industry.*



*The two-stage FRG Air Cleaner in operation on a Prentice 490 Skidder.*



*The FRG Air Cleaner on this Tyler Ag Sprayer eliminates 99.99% of the dirt from the engine airstream, while providing up to 945 cfm airflow to the engine.*



## Durable, Vibration Resistant Variety of Sizes in Two Separate Housing Styles

### Applications

- Horizontal installation
- Medium and heavy dust environments
- **Style A** — From 82 to 795 cfm airflow throughput per air cleaner in body diameters ranging from 5" to 16" (127 – 406mm)
- **Style B** — From 270 to 1390 cfm airflow throughput per air cleaner in body diameters ranging from 10" to 18" (254 – 457mm)

### Ideal for

- Construction equipment
- Agricultural machinery
- Mining equipment
- Off-highway vehicles

### Air Cleaner Features

- Two-stage filter system: the first stage removes up to 85% of incoming dust
  - The first stage in the Style A uses the angled vanes on the primary filter
  - The first stage in the Style B has a tangential air inlet
- Inlet on side, outlet on end (G flow)
- Already tapped to accept filter service indicator
- Vacuator™ Valve automatically releases the pre-cleaned dust
- Recommended Vacuator Valve orientation angle is  $\pm 30^\circ$
- Durable, long-lasting finish
  - Style A housing is metal and coated with a black, corrosion- and chemical-resistant polymer paint (service cover is accessed with clamp and bolt)
  - Style B is comprised of two materials: injection molded, high strength polymer service cover and a metal body (the service cover is accessed by latches)
- Mounting the unit directly to the engine is not recommended; excessive engine vibration can cause premature air cleaner structural failure

#### FRG Style A

The FRG Style A series replaces Donaldson's obsolete FHG series in size and airflow capacity.



While it looks like an axial seal air cleaner on the outside, this new style housing is equipped with a RadialSeal™ style primary filter and an optional safety filter. Easy to service; one wing-bolt clamp to undo to access filter(s).

#### FRG Style B

The FRG Style B series replaces Donaldson's obsolete FTG series in size and airflow capacity.



Injection-molded endcap, made of specially-engineered resins for high strength and durability, serves as the service cover. Filter change out is easier than ever — just unsnap the latches to access the filter.

### Filter Features

The RadialSeal™ filter inside the air cleaner is also quite different from Axial filters. Its one-piece, molded urethane endcaps encase the filter media and liners, thereby reducing the number of components and increasing sealing reliability.



The inside surface of the filter's open end is the sealing surface, which eliminates the glued-on gasket found on the metal end cap of Axial filters. For added engine protection during filter service, consider a model with a safety filter.

High efficiency, extended service, Donaldson Blue® filters are available on some models (see service parts list on pages 134 and 135 for part numbers)

### FRG Mounting Bands

- Two mounting bands are required for proper FRG installation (see service parts listing in this section).
- Durable, corrosion resistant, galvanized steel construction.
- Engineered and tested to resist the adverse effects of vibration.
- Mounting band feet are designed to continuously ensure maximum torque pressure.
- Dimensional information for mounting bands can be found in the accessories section.



### Accessories

Donaldson intake accessories for your FRG Air Cleaner can help overcome or prevent various problems. For instance:

- If the installed air cleaner will be exposed to rain, snow or debris, an **inlet cap** can prevent moisture ingestion.
- A **filter service indicator** measures the airflow restriction across the filter and indicates when to replace the filter (see Accessories section of this catalog).
- **Mounting bands** for FRGs must be ordered separately.

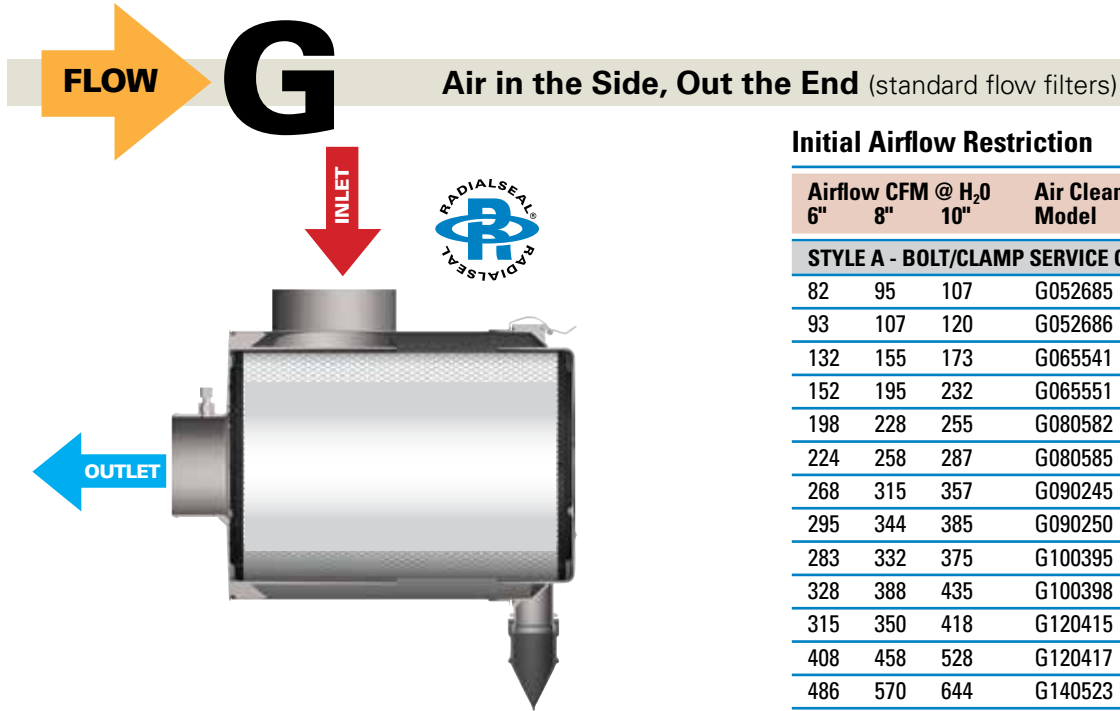

**Initial Airflow Restriction**

| Airflow CFM @ H <sub>2</sub> O            |      | Air Cleaner Model | Weight  |      |      |
|---|------|-------------------|---------|------|------|
| 6"  | 8"   |                   | lbs     | kg   |      |
| <b>STYLE A - BOLT/CLAMP SERVICE COVER</b> |      |                   |         |      |      |
| 82  | 95   | 107               | G052685 | 5.5  | 2.5  |
| 93  | 107  | 120               | G052686 | 5.2  | 2.4  |
| 132                                       | 155  | 173               | G065541 | 7.6  | 3.4  |
| 152                                       | 195  | 232               | G065551 | 7.1  | 3.2  |
| 198                                       | 228  | 255               | G080582 | 11.0 | 5.0  |
| 224                                       | 258  | 287               | G080585 | 10.5 | 4.8  |
| 268                                       | 315  | 357               | G090245 | 13.1 | 5.9  |
| 295                                       | 344  | 385               | G090250 | 12.1 | 5.5  |
| 283                                       | 332  | 375               | G100395 | 30.1 | 13.7 |
| 328                                       | 388  | 435               | G100398 | 28.6 | 13.0 |
| 315                                       | 350  | 418               | G120415 | 26.5 | 12.0 |
| 408                                       | 458  | 528               | G120417 | 28.1 | 12.7 |
| 486                                       | 570  | 644               | G140523 | 34.9 | 15.8 |
| 560                                       | 657  | 742               | G140526 | 33.3 | 15.1 |
| 590                                       | 700  | 795               | G160679 | 41.7 | 18.9 |
| <b>STYLE B - LATCH SERVICE COVER</b>      |      |                   |         |      |      |
| 270                                       | 305  | 340               | G100297 | 12.0 | 5.4  |
| 300                                       | 360  | 400               | G110214 | 13.1 | 5.9  |
| 370                                       | 430  | 490               | G110206 | 17.5 | 8.0  |
| 440                                       | 510  | 570               | G130107 | 20.6 | 9.3  |
| 520                                       | 590  | 655               | G130097 | 25.0 | 11.4 |
| 715                                       | 805  | 945               | G150092 | 30.0 | 13.6 |
| 1040                                      | 1230 | 1390              | G180031 | 44.0 | 20.0 |

**When Selecting an Air Cleaner . . .**

Determine the airflow requirements of your engine, then find the corresponding cfm airflow in the table at right. The restriction numbers (shown in inches of water) indicate the approximate initial restriction of each model air cleaner at that cfm. If there are two air cleaner models that fit your parameters, choosing the one with the lower restriction will provide longer filter service life. When calculating total initial restriction of the entire air intake system, include the restriction caused by ducting, elbows, and pre-cleaners. See pages 271-272 for ducting restriction estimates.

**FRG Air Cleaner Performance Curves (Restriction & Dust Capacity)\***

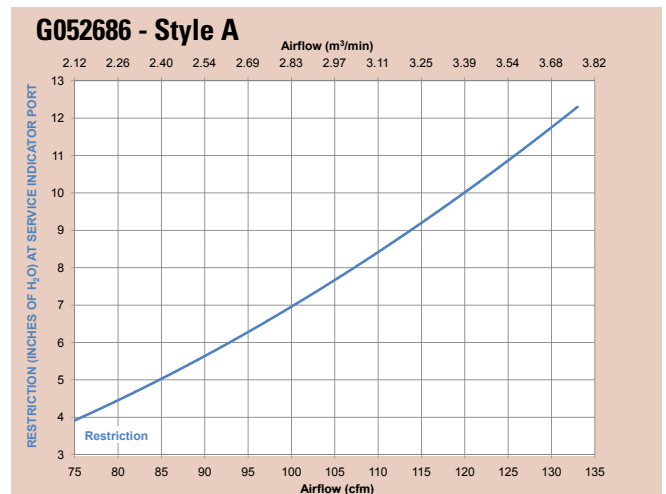
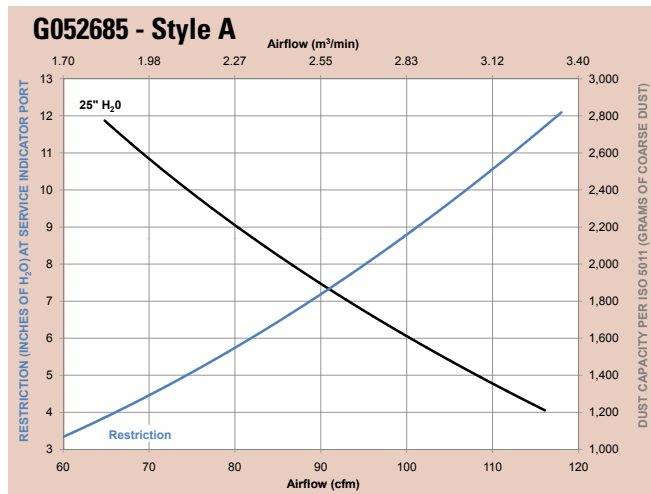

\*Results generated using laboratory testing pursuant to ISO5011. Actual performance during use may vary depending on multiple factors, including specific product configuration, external conditions and application.



## continued — FRG Air Cleaner Performance Curves (Restriction & Dust Capacity)

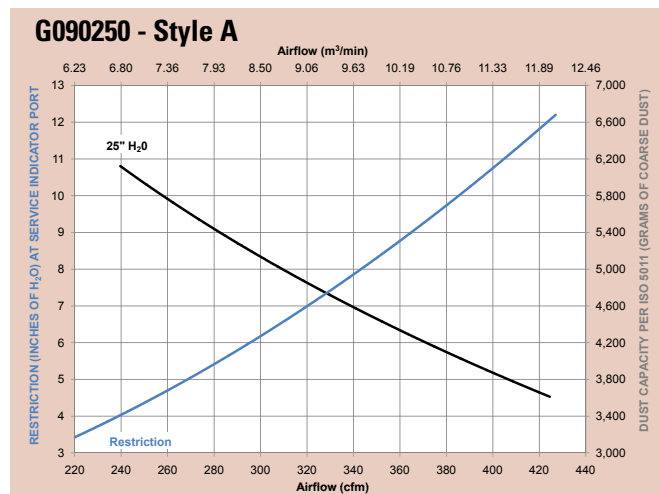
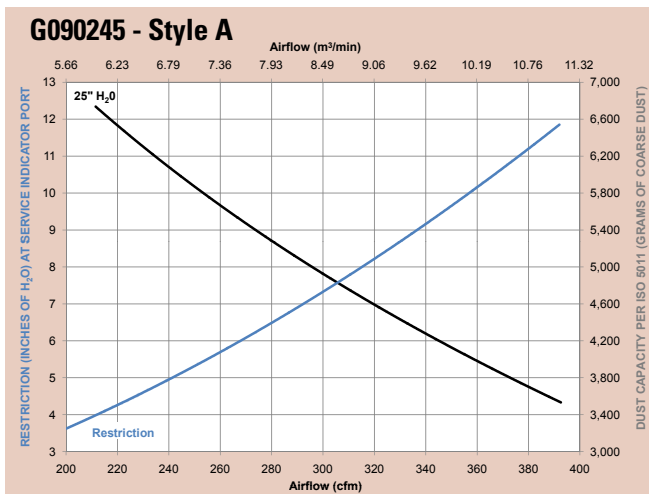
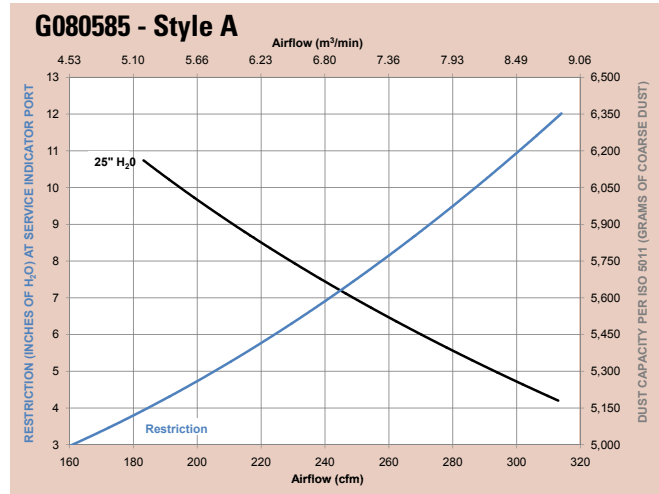
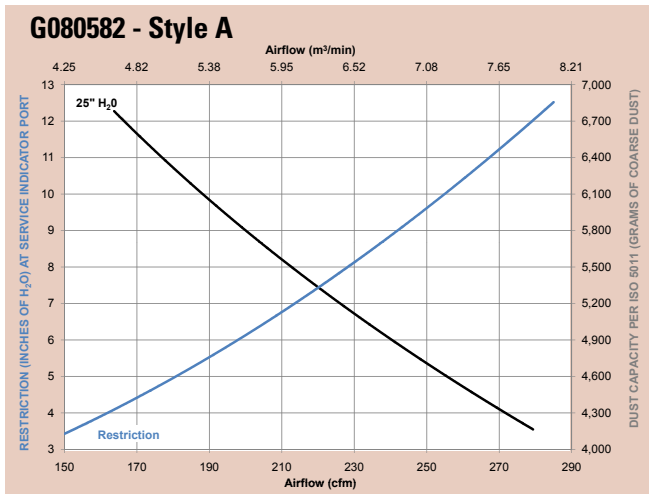
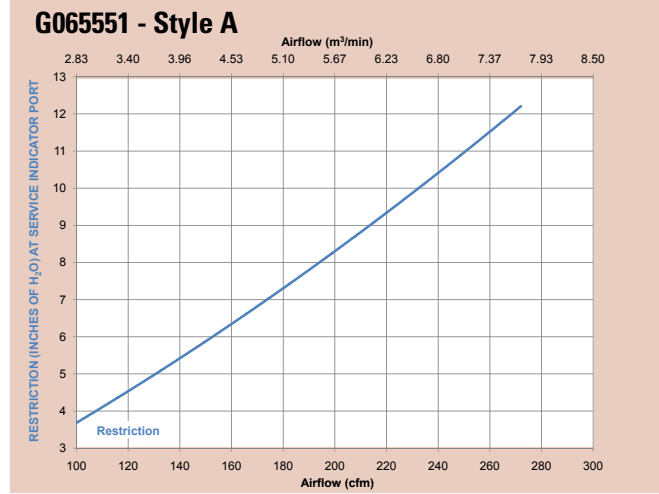
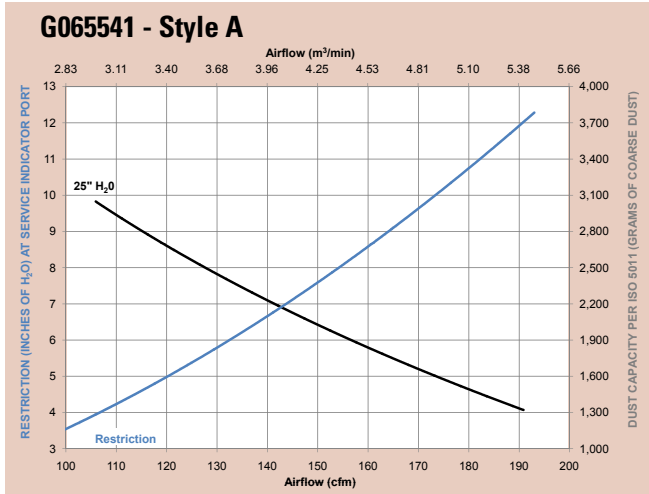

continued — FRG Air Cleaner Performance Curves (Restriction & Dust Capacity)

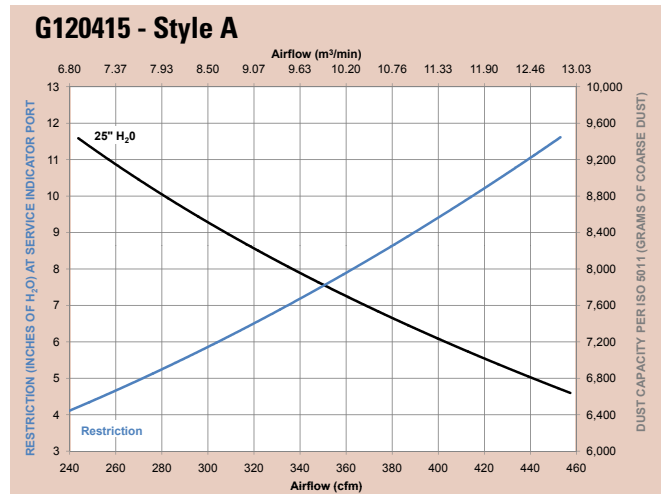
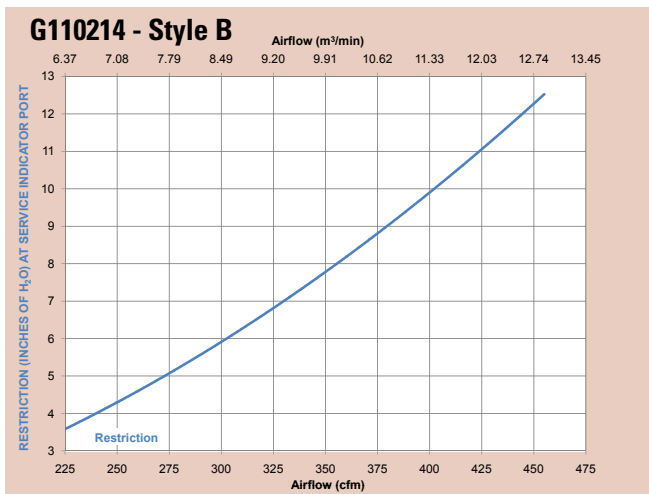
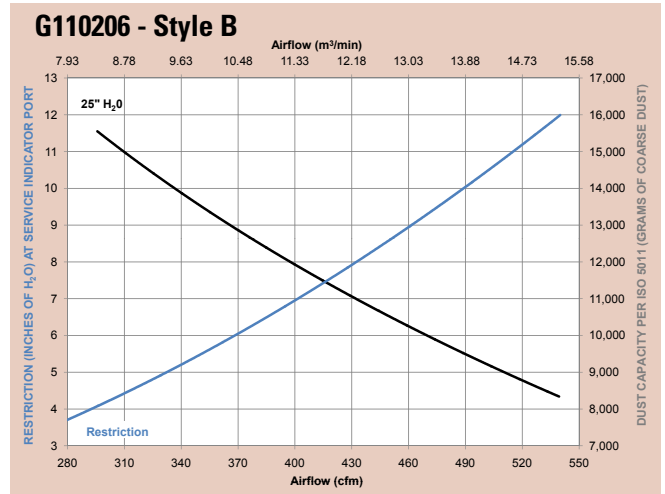
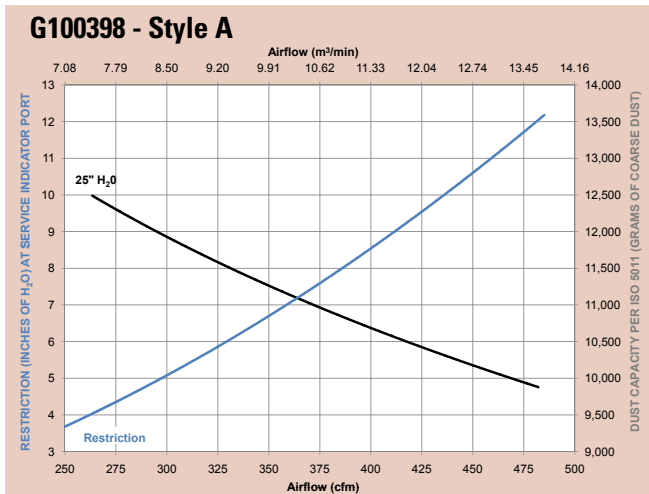
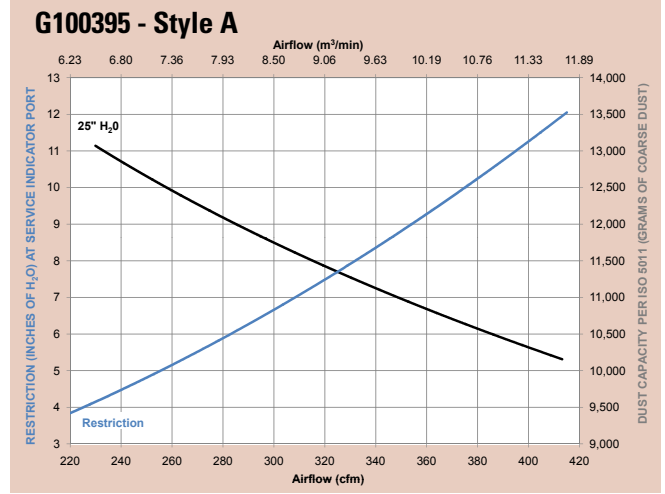
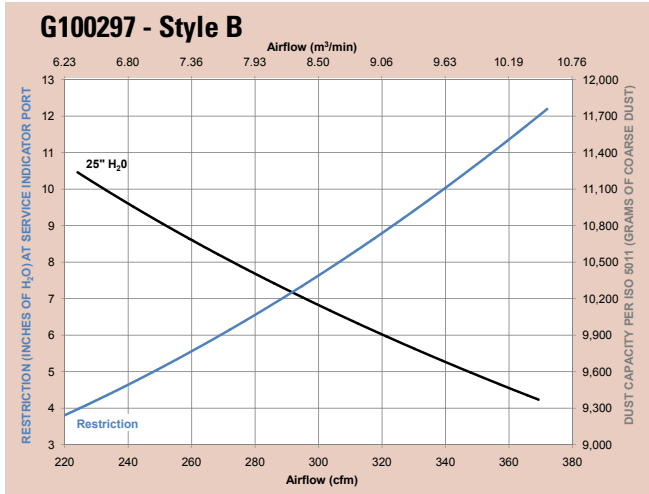



continued — FRG Air Cleaner Performance Curves (Restriction & Dust Capacity)

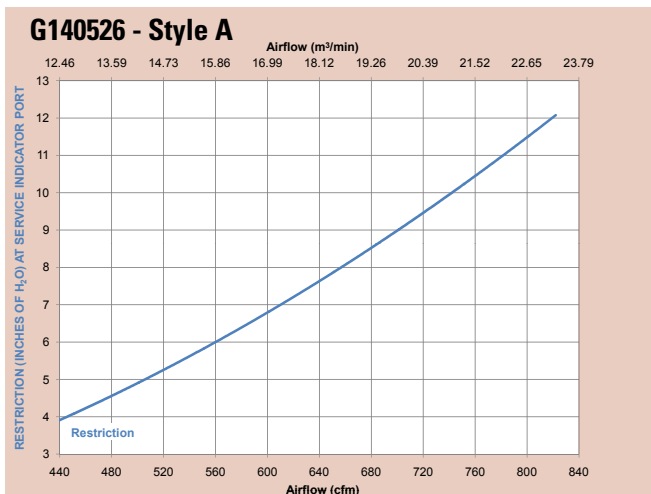
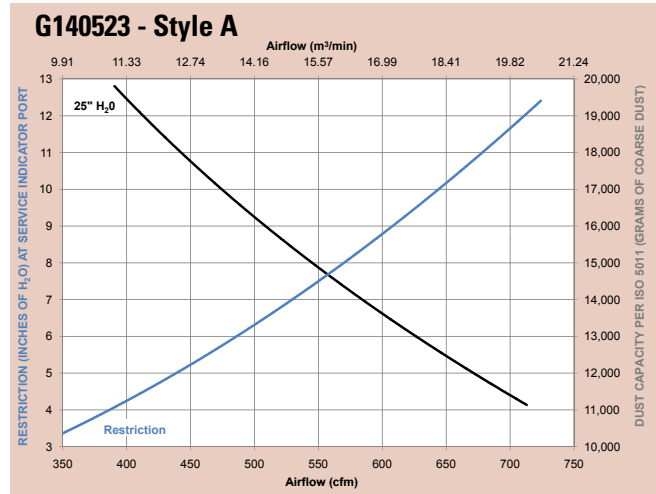
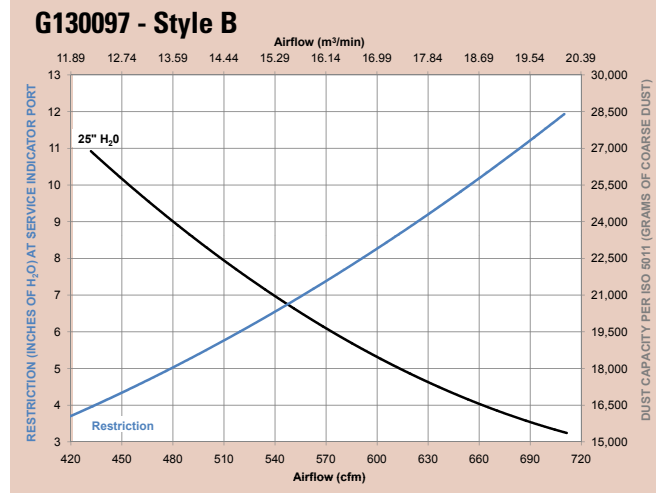
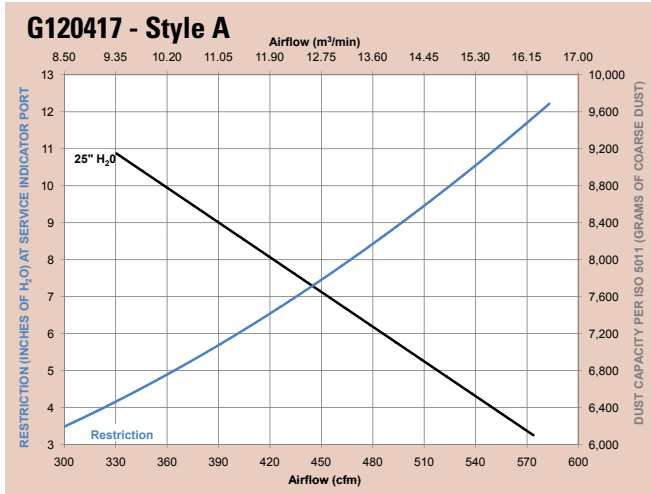

continued — FRG Air Cleaner Performance Curves (Restriction & Dust Capacity)

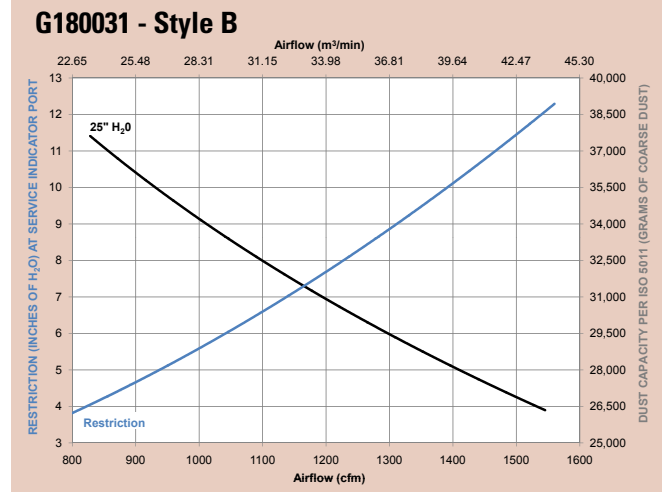
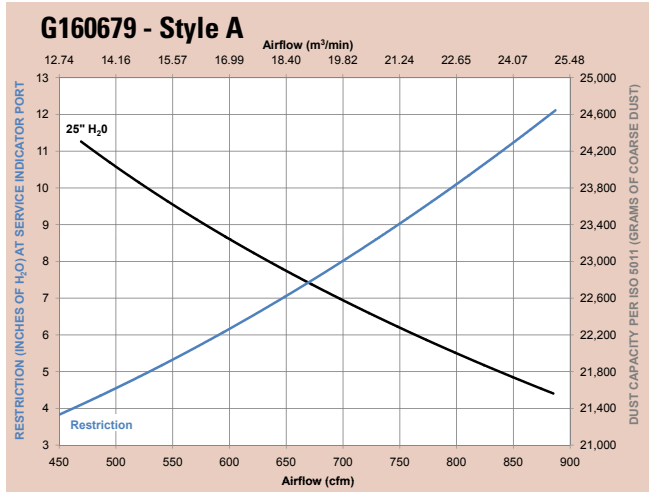

**FRG Specification Illustrations**

Style B — Latch Service Cover (Style A on next page)

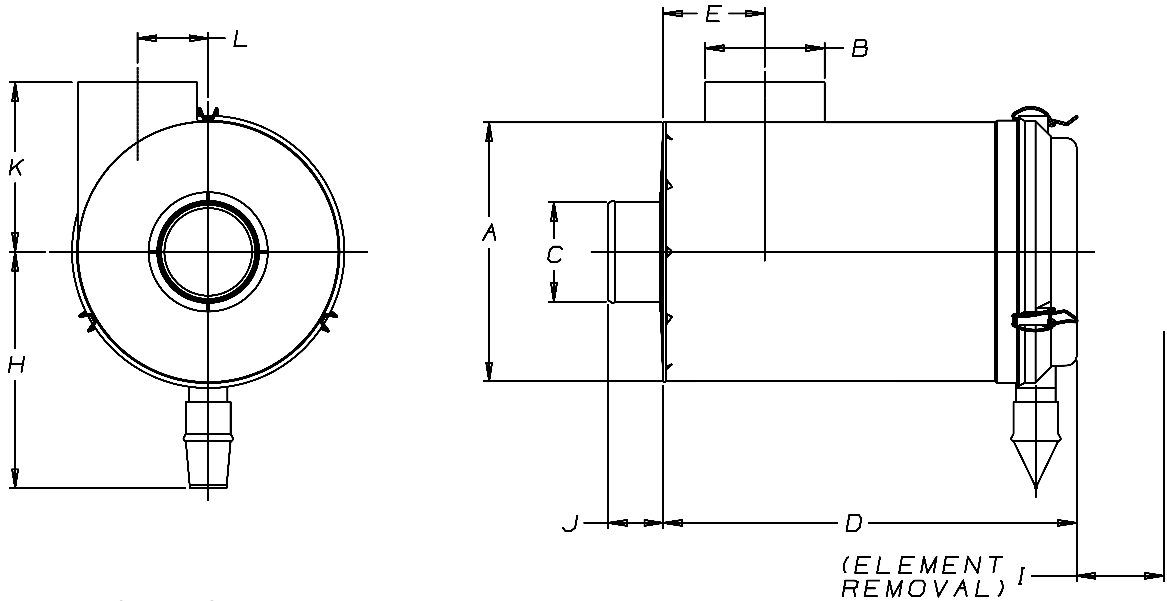

**FRG Specifications (Style B)**

| Air Cleaner Models                   | Body Diameter (A) |     | Inlet Diameter (B) |     | Outlet Diameter (C) |     | Housing Length (D) |     | Inlet Location (E) |     | Center Line to Valve (H) |     | Service Clearance (I) |     | Outlet Length (J) |    | Inlet Length (K) |     | Offset Inlet Location (L) |     |
|--------------------------------------|-------------------|-----|--------------------|-----|---------------------|-----|--------------------|-----|--------------------|-----|--------------------------|-----|-----------------------|-----|-------------------|----|------------------|-----|---------------------------|-----|
|                                      | in                | mm  | in                 | mm  | in                  | mm  | in                 | mm  | in                 | mm  | in                       | mm  | in                    | mm  | in                | mm | in               | mm  | in                        | mm  |
| <b>STYLE B - LATCH SERVICE COVER</b> |                   |     |                    |     |                     |     |                    |     |                    |     |                          |     |                       |     |                   |    |                  |     |                           |     |
| G100297                              | 10.2              | 259 | 4.5                | 114 | 4.0                 | 102 | 16.93              | 430 | 3.54               | 90  | 10.63                    | 270 | 15.00                 | 373 | 2.59              | 66 | 8.07             | 205 | 2.81                      | 72  |
| G110214                              | 11.0              | 279 | 5.0                | 127 | 4.5                 | 114 | 13.78              | 350 | 4.13               | 105 | 10.81                    | 275 | 17.00                 | 428 | 2.64              | 67 | 7.50             | 191 | 2.96                      | 75  |
| G110206                              | 11.0              | 279 | 5.0                | 127 | 4.5                 | 114 | 19.28              | 490 | 4.13               | 105 | 10.81                    | 275 | 17.00                 | 428 | 2.64              | 67 | 7.50             | 191 | 2.96                      | 75  |
| G130107                              | 13.0              | 330 | 6.0                | 152 | 5.0                 | 127 | 16.73              | 425 | 5.22               | 132 | 11.85                    | 301 | 18.00                 | 450 | 2.64              | 67 | 8.50             | 216 | 3.54                      | 90  |
| G130097                              | 13.0              | 330 | 6.0                | 152 | 5.0                 | 127 | 20.87              | 530 | 5.22               | 132 | 11.85                    | 301 | 18.00                 | 450 | 2.64              | 67 | 8.50             | 216 | 3.54                      | 90  |
| G150092                              | 15.0              | 381 | 7.0                | 178 | 6.0                 | 152 | 20.87              | 530 | 5.51               | 140 | 13.31                    | 338 | 19.00                 | 482 | 2.75              | 70 | 9.50             | 241 | 4.03                      | 102 |
| G180031                              | 18.0              | 457 | 8.0                | 203 | 8.0                 | 203 | 25.60              | 650 | 5.04               | 128 | 15.80                    | 402 | 28.62                 | 600 | 3.35              | 85 | 11.42            | 290 | 5.05                      | 128 |



## FRG Specification Illustrations

### Style A — Bolt/Clamp Service Cover

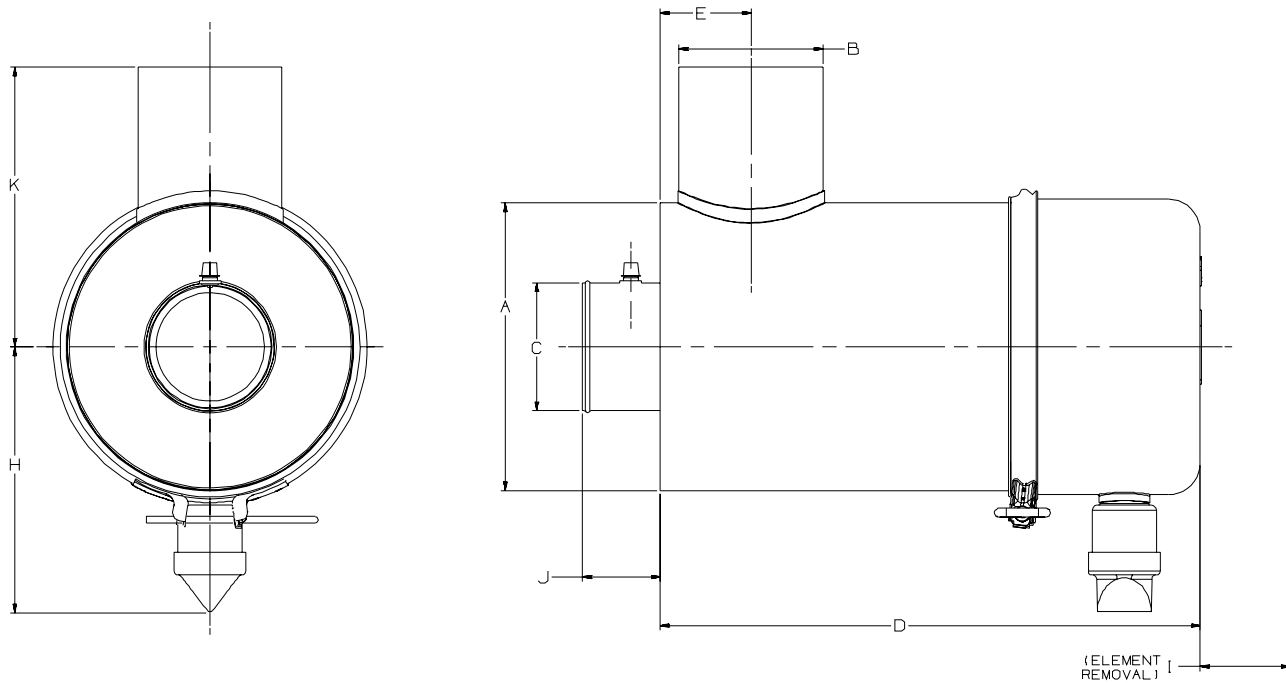

### FRG Specifications (Style A)

| Air Cleaner Models                        | Body Diameter (A) |     | Inlet Diameter (B) |     | Outlet Diameter (C) |     | Housing Length (D) |     | Inlet Location (E) |     | Center Line to Valve (H) |     | Service Clearance (I) |     | Outlet Length (J) |    | Inlet Length (K) |     |
|---|-------------------|-----|--------------------|-----|---------------------|-----|--------------------|-----|--------------------|-----|--------------------------|-----|-----------------------|-----|-------------------|----|------------------|-----|
|   | in                | mm  | in                 | mm  | in                  | mm  | in                 | mm  | in                 | mm  | in                       | mm  | in                    | mm  | in                | mm | in               | mm  |
| <b>STYLE A - BOLT/CLAMP SERVICE COVER</b> |                   |     |                    |     |                     |     |                    |     |                    |     |                          |     |                       |     |                   |    |                  |     |
| G052685                                   | 5.25              | 133 | 2.50               | 64  | 2.50                | 64  | 14.76              | 375 | 2.06               | 52  | 6.36                     | 162 | 9.80                  | 249 | 2.30              | 58 | 4.97             | 126 |
| G052686                                   | 5.25              | 133 | 2.50               | 64  | 2.50                | 64  | 14.76              | 375 | 2.06               | 52  | 6.36                     | 162 | 9.80                  | 249 | 2.30              | 58 | 4.97             | 126 |
| G065541                                   | 6.55              | 166 | 3.00               | 76  | 3.00                | 76  | 15.44              | 392 | 1.92               | 49  | 6.28                     | 160 | 12.31                 | 313 | 2.22              | 56 | 6.38             | 162 |
| G065551                                   | 6.55              | 166 | 3.00               | 76  | 3.00                | 76  | 15.44              | 392 | 1.92               | 49  | 6.28                     | 160 | 12.31                 | 313 | 2.22              | 56 | 6.38             | 162 |
| G080582                                   | 8.00              | 203 | 3.75               | 95  | 3.50                | 89  | 15.84              | 402 | 2.38               | 60  | 7.96                     | 202 | 12.44                 | 316 | 2.46              | 62 | 7.25             | 184 |
| G080585                                   | 8.00              | 203 | 3.75               | 95  | 3.50                | 89  | 15.84              | 402 | 2.38               | 60  | 7.96                     | 202 | 12.44                 | 316 | 2.46              | 62 | 7.25             | 184 |
| G090245                                   | 9.00              | 229 | 4.50               | 114 | 4.00                | 102 | 16.90              | 429 | 2.84               | 72  | 8.27                     | 210 | 16.90                 | 429 | 2.43              | 62 | 8.75             | 222 |
| G090250                                   | 9.00              | 229 | 4.50               | 114 | 4.00                | 102 | 16.90              | 429 | 2.84               | 72  | 8.27                     | 210 | 16.90                 | 429 | 2.43              | 62 | 8.75             | 222 |
| G100395                                   | 10.19             | 259 | 4.50               | 114 | 5.00                | 127 | 21.03              | 534 | 3.38               | 86  | 8.96                     | 228 | 13.06                 | 332 | 2.10              | 53 | 8.09             | 205 |
| G100398                                   | 10.19             | 259 | 4.50               | 114 | 5.00                | 127 | 21.03              | 534 | 3.38               | 86  | 8.96                     | 228 | 13.06                 | 332 | 2.10              | 53 | 8.09             | 205 |
| G120415                                   | 12.00             | 305 | 5.00               | 127 | 5.00                | 127 | 19.06              | 484 | 4.69               | 119 | 9.62                     | 244 | 9.10                  | 231 | 2.28              | 58 | 8.92             | 227 |
| G120417                                   | 12.00             | 305 | 5.00               | 127 | 5.00                | 127 | 19.06              | 484 | 4.69               | 119 | 9.62                     | 244 | 9.10                  | 231 | 2.28              | 58 | 8.92             | 227 |
| G140523                                   | 14.00             | 356 | 6.00               | 152 | 6.00                | 152 | 22.06              | 560 | 5.28               | 134 | 10.72                    | 272 | 12.10                 | 307 | 2.26              | 57 | 10.12            | 257 |
| G140526                                   | 14.00             | 356 | 6.00               | 152 | 6.00                | 152 | 22.06              | 560 | 5.28               | 134 | 10.72                    | 272 | 12.10                 | 307 | 2.26              | 57 | 10.12            | 257 |
| G160679                                   | 16.00             | 406 | 7.00               | 178 | 7.00                | 178 | 24.04              | 611 | 5.76               | 146 | 11.72                    | 298 | 14.10                 | 358 | 2.29              | 58 | 12.00            | 305 |



## FRG Service Parts

### Style A — Bolt/Clamp Service Cover

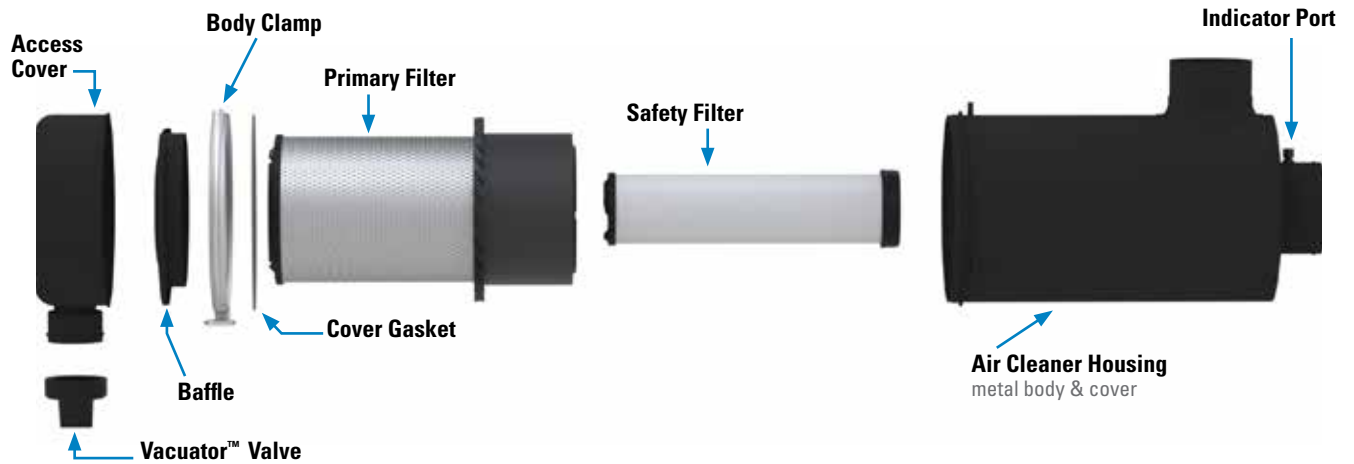

### Style B — Latch Service Cover

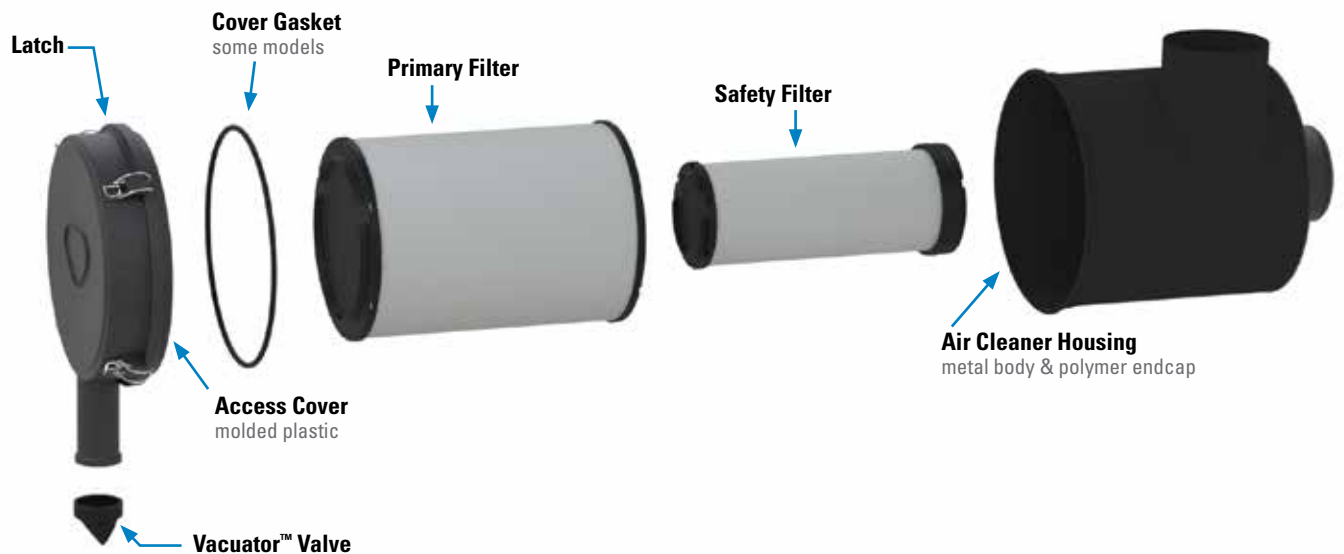

## FRG Service Parts & Accessories

### G052685 FRG Style A

|  |                |
|--|----------------|
| Clamp .....                                    | P002904        |
| Cover .....                                    | P120279        |
| Elbow, 45° .....                               | P105543        |
| Elbow, 90° .....                               | P105531        |
| Filter, primary .....                          | P600043 .....3 |
| Filter, safety .....                           | P600047 .....3 |
| Informer™ indicator 25" H <sub>2</sub> O ..... | X002277        |
| Inlet hood, plastic .....                      | H001378        |
| Mounting band .....                            | P002348 .....2 |
| Mounting bands, metal .....                    | P002348        |
| Outlet band clamp .....                        | P148339        |
| Vacuator™ Valve .....                          | P158914        |

### G052686 FRG Style A

|  |                |
|--|----------------|
| Clamp .....                                    | P002904        |
| Cover .....                                    | P120279        |
| Elbow, 45° .....                               | P105543        |
| Elbow, 90° .....                               | P105531        |
| Filter, primary .....                          | P600043 .....3 |
| Filter, safety (optional) .....                | P600047        |
| Informer™ indicator 25" H <sub>2</sub> O ..... | X002277        |
| Inlet hood, plastic .....                      | H001378        |
| Mounting band .....                            | P002348 .....2 |
| Outlet band clamp .....                        | P148339        |
| Vacuator™ Valve .....                          | P158914        |

#### SERVICE PARTS NOTES:

- 2 = Two required for proper installation
- 3 = Shipped with air cleaner initially
- 8 = Cover assembly includes latches but no Vacuator™ Valve
- Donaldson Blue® = High Efficiency, Extended Service

**G065541 FRG Style A**

|  |                |
|--|----------------|
| Clamp                                    | P002940        |
| Cover                                    | P522133        |
| Elbow, 45°                               | P105544        |
| Elbow, 90°                               | P105532        |
| Elbow, 90° reducing                      | P123462        |
| Filter, primary                          | P549271 .....3 |
| Filter, safety                           | P549277 .....3 |
| Hump hose                                | P105608        |
| Informer™ indicator 25" H <sub>2</sub> O | X002277        |
| Inlet hood, plastic                      | H001379        |
| Mounting band                            | P007191 .....2 |
| Outlet band clamp                        | P148341        |
| Vacuator™ Valve                          | P158914        |

**G065551 FRG Style A**

|  |                |
|--|----------------|
| Clamp                                    | P002940        |
| Cover                                    | P522133        |
| Elbow, 45°                               | P105544        |
| Elbow, 90°                               | P105532        |
| Elbow, 90° reducing                      | P123462        |
| Filter, primary                          | P549271 .....3 |
| Filter, safety (optional)                | P549277        |
| Hump hose                                | P105608        |
| Informer™ indicator 25" H <sub>2</sub> O | X002277        |
| Inlet hood, plastic                      | H001379        |
| Mounting band                            | P007191 .....2 |
| Outlet band clamp                        | P148341        |
| Vacuator™ Valve                          | P158914        |

**G080582 FRG Style A**

|  |                |
|--|----------------|
| Clamp                                    | P003951        |
| Cover                                    | P600321        |
| Elbow, 45°                               | P109331        |
| Elbow, 90°                               | P114318        |
| Filter, primary-Donaldson Blue®          | DBA5223        |
| Filter, primary                          | P601437 .....3 |
| Filter, safety                           | P601476 .....3 |
| Hump hose                                | P114319        |
| Informer™ indicator 25" H <sub>2</sub> O | X002277        |
| Inlet hood, plastic                      | H000466        |
| Mounting band                            | P004307 .....2 |
| Outlet band clamp                        | P148342        |
| Vacuator™ Valve                          | P158914        |

**G080585 FRG Style A**

|  |                |
|--|----------------|
| Cover                                    | P600321        |
| Elbow, 45°                               | P109331        |
| Elbow, 90°                               | P114318        |
| Filter, primary-Donaldson Blue®          | DBA5223        |
| Filter, primary                          | P601437 .....3 |
| Filter, safety (optional)                | P601476        |
| Hump hose                                | P114319        |
| Informer™ indicator 25" H <sub>2</sub> O | X002277        |
| Inlet hood, plastic                      | H000466        |
| Mounting band                            | P004307 .....2 |
| Outlet band clamp                        | P148342        |
| Vacuator™ Valve                          | P158914        |

**G090245 FRG Style A**

|  |                |
|--|----------------|
| Clamp                                    | P102025        |
| Cover                                    | P600657        |
| Elbow, 45°                               | P105545        |
| Elbow, 90°                               | P105533        |
| Elbow, 90° reducing                      | P121482        |
| Filter, primary-Donaldson Blue®          | DBA5224        |
| Filter, primary                          | P601280 .....3 |
| Filter, safety                           | P601286 .....3 |
| Hump hose                                | P105609        |
| Informer™ indicator 25" H <sub>2</sub> O | X002277        |
| Inlet hood, metal                        | H000170        |
| Inlet hood, plastic                      | H000468        |
| Mounting band                            | P004073 .....2 |
| Outlet band clamp                        | P148343        |
| Vacuator™ Valve                          | P158914        |

**G090250 FRG Style A**

|  |                |
|--|----------------|
| Cover                                    | P600657        |
| Elbow, 45°                               | P105545        |
| Elbow, 90°                               | P105533        |
| Elbow, 90° reducing                      | P121482        |
| Filter, primary-Donaldson Blue®          | DBA5224        |
| Filter, primary                          | P601280 .....3 |
| Filter, safety (optional)                | P601286        |
| Hump hose                                | P105609        |
| Informer™ indicator 25" H <sub>2</sub> O | X002277        |
| Inlet hood, metal                        | H000170        |
| Inlet hood, plastic                      | H000468        |
| Mounting band                            | P004073 .....2 |
| Outlet band clamp                        | P148343        |
| Vacuator™ Valve                          | P158914        |

**G100297 FRG Style B**

|  |                |
|--|----------------|
| Cover                                    | P538200 .....8 |
| Elbow, 45°                               | P105545        |
| Elbow, 90°                               | P105533        |
| Elbow, 90° reducing                      | P121482        |
| Filter, primary-Donaldson Blue®          | DBA5228        |
| Filter, primary                          | P781039 .....3 |
| Filter, safety                           | P777639 .....3 |
| Gasket, cover                            | P537308        |
| Hump hose                                | P105609        |
| Informer™ indicator 25" H <sub>2</sub> O | X002277        |
| Inlet hood, plastic                      | H000468        |
| Latch                                    | P777366        |
| Mounting band                            | P004076 .....2 |
| Outlet band clamp                        | P148343        |
| Vacuator™ Valve                          | P776008        |

**G100395 FRG Style A**

|  |                |
|--|----------------|
| Baffle, metal                            | P602211        |
| Clamp                                    | P106071        |
| Dust cup/cover                           | P103827        |
| Elbow, 45°                               | P109021        |
| Elbow, 90°                               | P107844        |
| Elbow, 90° reducing                      | P143895        |
| Filter, primary-Donaldson Blue®          | DBA5222        |
| Filter, primary                          | P601790 .....3 |
| Filter, safety (optional)                | P777639 .....3 |
| Hump hose                                | P105610        |
| Informer™ indicator 25" H <sub>2</sub> O | X002277        |
| Inlet hood, metal                        | H000170        |
| Inlet hood, plastic                      | H000468        |
| Mounting band                            | P004076 .....2 |
| O-ring                                   | P101401        |
| Outlet band clamp                        | P148345        |
| Vacuator™ Valve                          | P103198        |

**G100398 FRG Style A**

|  |                |
|--|----------------|
| Baffle, metal                            | P602211        |
| Clamp                                    | P106071        |
| Dust cup/cover                           | P103827        |
| Elbow, 45°                               | P109021        |
| Elbow, 90°                               | P107844        |
| Elbow, 90° reducing                      | P143895        |
| Filter, primary-Donaldson Blue®          | DBA5222        |
| Filter, primary                          | P601790 .....3 |
| Filter, safety (optional)                | P777639        |
| Hump hose                                | P105610        |
| Informer™ indicator 25" H <sub>2</sub> O | X002277        |
| Inlet hood, metal                        | H000170        |
| Inlet hood, plastic                      | H000468        |
| Mounting band                            | P004076 .....2 |
| Mounting bands, metal                    | P004076        |
| O-ring                                   | P101401        |
| Outlet band clamp                        | P148345        |
| Vacuator™ Valve                          | P103198        |

**G110206 FRG Style B**

|  |                |
|--|----------------|
| Cover                                    | P538452 .....8 |
| Elbow, 45°                               | P114316        |
| Elbow, 90°                               | P113733        |
| Filter, primary-Donaldson Blue®          | DBA5105        |
| Filter, primary - SM                     | P532966 .....3 |
| Filter, safety                           | P533781 .....3 |
| Gasket, cover                            | P526676        |
| Hump hose                                | P114317        |
| Informer™ indicator 25" H <sub>2</sub> O | X002277        |
| Inlet hood, metal                        | H000165        |
| Inlet hood, plastic                      | H000469        |
| Latch                                    | P536439        |
| Mounting band                            | P004079 .....2 |
| Outlet band clamp                        | P148344        |
| Vacuator™ Valve                          | P158914        |

**G110214 FRG Style B**

|  |                |
|--|----------------|
| Cover                                    | P538452 .....8 |
| Elbow, 45°                               | P114316        |
| Elbow, 90°                               | P113733        |
| Filter, primary-Donaldson Blue®          | DBA5230        |
| Filter, primary                          | P536457 .....3 |
| Filter, safety                           | P536492 .....3 |
| Gasket, cover                            | P526676        |
| Hump hose                                | P114317        |
| Informer™ indicator 25" H <sub>2</sub> O | X002277        |
| Inlet hood, metal                        | H000170        |
| Inlet hood, plastic                      | H000468        |
| Latch                                    | P536439        |
| Mounting band                            | P004079 .....2 |
| Outlet band clamp                        | P148344        |
| Vacuator™ Valve                          | P158914        |



## G120415 FRG Style A

|   |                |
|---|----------------|
| Baffle, metal.....                            | P106329        |
| Clamp.....                                    | P121067        |
| Dust cup/cover.....                           | P109296        |
| Elbow, 45°.....                               | P109021        |
| Elbow, 90°.....                               | P107844        |
| Elbow, 90° reducing.....                      | P143895        |
| Filter, primary-Donaldson Blue®... DBA5231    |                |
| Filter, primary.....                          | P601767 .....3 |
| Filter, safety.....                           | P601774 .....3 |
| Hump hose.....                                | P105610        |
| Informer™ indicator 25" H <sub>2</sub> O..... | X002277        |
| Inlet hood, metal.....                        | H000165        |
| Inlet hood, plastic.....                      | H000469        |
| Mounting band.....                            | H000349 .....2 |
| O-ring.....                                   | P017804        |
| Outlet band clamp.....                        | P148345        |
| Vacuator™ Valve.....                          | P103198        |

## G120417 FRG Style A

|   |                |
|---|----------------|
| Baffle, metal.....                            | P106329        |
| Clamp.....                                    | P121067        |
| Dust cup/cover.....                           | P109296        |
| Elbow, 45°.....                               | P109021        |
| Elbow, 90°.....                               | P107844        |
| Elbow, 90° reducing.....                      | P143895        |
| Filter, primary-Donaldson Blue®... DBA5231    |                |
| Filter, primary.....                          | P601767 .....3 |
| Filter, safety (optional).....                | P601774        |
| Hump hose.....                                | P105610        |
| Informer™ indicator 25" H <sub>2</sub> O..... | X002277        |
| Inlet hood, metal.....                        | H000165        |
| Inlet hood, plastic.....                      | H000469        |
| Mounting band.....                            | H000349 .....2 |
| O-ring.....                                   | P017804        |
| Outlet band clamp.....                        | P148345        |
| Vacuator™ Valve.....                          | P103198        |

## G130097 FRG Style B

|   |                |
|---|----------------|
| Cover.....                                    | P538259 .....8 |
| Elbow, 45°.....                               | P109021        |
| Elbow, 90°.....                               | P107844        |
| Elbow, 90° reducing.....                      | P143895        |
| Filter, primary-Donaldson Blue®... DBA5221    |                |
| Filter, primary.....                          | P537876 .....3 |
| Filter, safety.....                           | P537877 .....3 |
| Gasket, cover.....                            | P537699        |
| Hump hose.....                                | P105610        |
| Informer™ indicator 25" H <sub>2</sub> O..... | X002277        |
| Inlet hood, metal.....                        | H000275        |
| Inlet hood, plastic.....                      | H000606        |
| Latch.....                                    | P776033        |
| Mounting band.....                            | P013722 .....2 |
| Outlet band clamp.....                        | P148345        |
| Vacuator™ Valve.....                          | P776008        |

## G130107 FRG Style B

|   |                |
|---|----------------|
| Cover.....                                    | P538259 .....8 |
| Elbow, 45°.....                               | P109021        |
| Elbow, 90°.....                               | P107844        |
| Elbow, 90° reducing.....                      | P143895        |
| Filter, primary-Donaldson Blue®... DBA5220    |                |
| Filter, primary.....                          | P532503 .....3 |
| Filter, safety.....                           | P532504 .....3 |
| Gasket, cover.....                            | P537699        |
| Hump hose.....                                | P105610        |
| Informer™ indicator 25" H <sub>2</sub> O..... | X002277        |
| Inlet hood, metal.....                        | H000275        |
| Inlet hood, plastic.....                      | H000606        |
| Latch.....                                    | P776033        |
| Mounting band.....                            | P013722 .....2 |
| Outlet band clamp.....                        | P148345        |
| Vacuator™ Valve.....                          | P776008        |

## G140523 FRG Style A

|   |                |
|---|----------------|
| Baffle, metal.....                            | P106771        |
| Clamp.....                                    | P100866        |
| Dust cup/cover.....                           | P109297        |
| Elbow, 45°.....                               | P105547        |
| Elbow, 90°.....                               | P105535        |
| Filter, primary-Donaldson Blue®... DBA5220    |                |
| Filter, primary.....                          | P532503 .....3 |
| Filter, safety.....                           | P532504 .....3 |
| Hump hose.....                                | P105612        |
| Informer™ indicator 25" H <sub>2</sub> O..... | X002277        |
| Inlet hood, metal.....                        | H000275        |
| Inlet hood, plastic.....                      | H000606        |
| Mounting band.....                            | H000350 .....2 |
| O-ring.....                                   | P017335        |
| Outlet band clamp.....                        | P148347        |
| Vacuator™ Valve.....                          | P103198        |

## G140526 FRG Style A

|   |                |
|---|----------------|
| Baffle, metal.....                            | P106771        |
| Clamp.....                                    | P100866        |
| Dust cup/cover.....                           | P109297        |
| Elbow, 45°.....                               | P105547        |
| Elbow, 90°.....                               | P105535        |
| Filter, primary-Donaldson Blue®... DBA5220    |                |
| Filter, primary.....                          | P532503 .....3 |
| Filter, safety (optional).....                | P532504        |
| Hump hose.....                                | P105612        |
| Informer™ indicator 25" H <sub>2</sub> O..... | X002277        |
| Inlet hood, metal.....                        | H000275        |
| Inlet hood, plastic.....                      | H000606        |
| Mounting band.....                            | H000350 .....2 |
| O-ring.....                                   | P017335        |
| Outlet band clamp.....                        | P148347        |
| Vacuator™ Valve.....                          | P103198        |

## G150092 FRG Style B

|   |                |
|---|----------------|
| Cover.....                                    | P777920 .....8 |
| Elbow, 45°.....                               | P105547        |
| Elbow, 90°.....                               | P105535        |
| Filter, primary-Donaldson Blue®... DBA5116    |                |
| Filter, primary.....                          | P777868 .....3 |
| Filter, safety.....                           | P777869 .....3 |
| Hump hose.....                                | P105612        |
| Informer™ indicator 25" H <sub>2</sub> O..... | X002277        |
| Inlet hood, metal.....                        | H000339        |
| Inlet hood, plastic.....                      | H000607        |
| Latch.....                                    | P776033        |
| Mounting band.....                            | P016845 .....2 |
| Outlet band clamp.....                        | P148347        |
| Vacuator™ Valve.....                          | P776008        |

## G160679 FRG Style A

|   |                |
|---|----------------|
| Baffle, metal.....                            | P106637        |
| Clamp.....                                    | P100789        |
| Dust cup/cover.....                           | P106952        |
| Elbow, 45°.....                               | P105548        |
| Elbow, 90°.....                               | P105536        |
| Filter, primary-Donaldson Blue®... DBA5229    |                |
| Filter, primary.....                          | P549523 .....3 |
| Filter, safety.....                           | P549530 .....3 |
| Hump hose.....                                | P105613        |
| Informer™ indicator 25" H <sub>2</sub> O..... | X002277        |
| Inlet hood, metal.....                        | H000339        |
| Inlet hood, plastic.....                      | H000607        |
| Mounting band.....                            | H000351 .....2 |
| O-ring.....                                   | P017336        |
| Outlet band clamp.....                        | P148348        |
| Vacuator™ Valve.....                          | P103198        |

## G180031 FRG Style B

|   |                |
|---|----------------|
| Cover.....                                    | P783185        |
| Elbow, 45°.....                               | P112606        |
| Elbow, 90°.....                               | P112605        |
| Filter, primary-Donaldson Blue®... DBA5156    |                |
| Filter, primary.....                          | P781098 .....3 |
| Filter, safety.....                           | P781102 .....3 |
| Hump hose.....                                | P112608        |
| Informer™ indicator 25" H <sub>2</sub> O..... | X002277        |
| Inlet hood, plastic.....                      | H001053        |
| Mounting band.....                            | H770037 .....2 |
| Outlet band clamp.....                        | P629991        |
| Vacuator™ Valve.....                          | P105220        |

### SERVICE PARTS NOTES:

- 2 = Two required for proper installation
- 3 = Shipped with air cleaner initially
- 7 = Included with each replacement filter
- 8 = Cover assembly includes latches, but no Vacuator Valve.

Donaldson Blue® = High Efficiency, Extended Service



This servicing information is provided as a best practices guide. It is not intended to replace or supersede the service instructions supplied by your engine or vehicle manufacturer.

### 1 Check the Restriction

Replace the filter only when the restriction level has reached the maximum recommended by the engine or equipment manufacturer or on a regular service schedule.



### 2 Remove the Primary Filter and check the Vacuator™ Valve

Shut off the engine. Unfasten or unlatch the service cover.

Because of its RadialSeal™, the filter fits tightly over the outlet tube and there will be some initial resistance, similar to breaking the seal on a jar. Gently move the end of the filter back and forth to break the seal then rotate while pulling straight out. Avoid knocking the filter against the housing.

If your air cleaner is equipped with a Vacuator™ Valve, visually check and physically squeeze it.



Make sure the valve is flexible and not inverted, damaged or plugged. Replace it if damaged or if it looks like any of these images. A damaged or missing vac valve will disrupt the designed flow of air through the air cleaner.

### 3 Visually Check the Safety Filter and Clean Both Surfaces of the Outlet Tube

If your air cleaner has a safety filter, visually check the safety filter in place for signs of damage. Do not remove the safety filter unless it is damaged or due for replacement. Also verify that the safety filter is properly seated in the housing.

The safety filter should be replaced every three primary filter changes. Use a clean damp cloth to wipe both the filter sealing surface and the inside of the outlet tube. Ensure that the outlet tube sealing area is undamaged.

Contaminant on the sealing surface could hinder an effective seal and cause leakage. If the safety filter is to be replaced, avoid leaving the outlet tube exposed to the air.

If there is to be a delay in installing the new safety filter, cover the air cleaner outlet tube to avoid admitting any dust.



## 4 Inspect the Old Filter

Inspect the old filter for any signs of leaks. A streak of dust on the clean side of the filter is a telltale sign. Eliminate any source of air leaks before installing the new primary filter.



## 5 Inspect the New Filter

Inspect the new filter for any damage that may have occurred through mishandling. NEVER install a damaged filter. Visually check the inside of the open end, which is the sealing area.

Do not wipe the filter RadialSeal™ area as the new Donaldson RadialSeal filter may have a dry lubricant on the seal to aid installation.



## 6 Insert the New Filter

First, if you're servicing the safety filter at this change-out, seat it properly into position before installing the primary filter. Insert new filters carefully. Seat the primary filter by hand, making certain it is inserted completely into the air cleaner housing. To complete a tight seal, apply pressure by hand at the outer rim of the filter, not the flexible center.

No cover pressure is required to hold the seal in place and one should NEVER use the service cover to apply pressure. This could damage the housing and fasteners and void the warranty. If the service cover presses against the filter before the cover is fully in place, remove the cover. With cover off, push the filter farther into the air cleaner by hand and then the cover will go on with no extra force. Once the filter is in place, secure the service cover.



Continued on next page



### 7 Check Inlet Hoods and Pre-Cleaners

Check any intake hoods and pre-cleaner devices during maintenance routines.

A missing inlet hood will significantly shorten filter life. If your unit had a hood or pre-cleaner originally, make sure you replace it. Check openings and tubes on pre-cleaners to make sure they are not plugged. Replace any units that are damaged. Damaged or dented units will not operate properly.



### 8 Check Connectors for Tight Fit

Make sure service indicators are reset and in proper working order.

Check that all mounting bands, clamps, bolts, and connections in the entire air cleaner system are tight.

Check for holes in piping, and repair or replace as needed.

Any leaks in the intake piping will admit dust directly to the engine.

