



## Mix&Match to Get What You Need

Donaldson's Mix&Match system provides the great performance and functional advantages of custom-engineered filters with the convenience and speedy delivery of in-stock parts. Choose your options and build a filter model that exactly suits your cleanliness requirements.

### Technical Data

- Operating pressure up to 42 MPa (420 bar).
- Static pressure testing up to 63 MPa (630 bar).
- Fatigue pressure of 2.000.000 cycles at 0-30 MPa (0-300 bar) per NFPA T 3.10.5.1, R2-2000.
- By-pass valve setting 600 kPa (6 bar) per ISO3968.
- Optional: Reverse flow valve which allows fluid to pass through the element in one direction but to by-pass the element when the flow is reversed.
- Operating temperature -20 +120°C.
- Compatibility with hydraulic fluids per ISO 2943.
- Flow rate and pressure drop per ISO3968 with oil kinematic viscosity 30 cSt at 40°C and density 0,875 kg/dm<sup>3</sup>.
- Filter head casting in spheroidal cast iron.
- Extruded steel bowl.
- Flange per SAE J518: 6000 PSI.

### Filter Elements

- Synteq® synthetic media: 8-11-23 micron, reinforced with wire mesh.
- Collapse resistance 2 MPa (20 bar) per ISO 2941.
- Available collapse resistance 21MPa (210bar) – on customer request.



## Components

		SYNTHETIC MEDIA						CARTRIDGE CODE
		/03		XP10		XP5		
		B <sub>23µlcl</sub> ≥1000		B <sub>11µlcl</sub> ≥1000		B <sub>8µlcl</sub> ≥1000		
Family	Collapse	RMF		RMF		RMF		
AP361	Standard	50	P171733	50	P171732	40	P171731	AP451
	High		P176621		P176620		P176619	AP551
AP362	Standard	80	P171736	80	P171735	60	P171734	AP452
	High		P176624		P176623		P176622	AP552
AP363	Standard	120	P171739	120	P171738	80	P171737	AP453
	High		P176627		P176626		P176625	AP553
AP364	Standard	180	P171742	180	P171741	160	P171740	AP454
	High		P176630		P176629		P176628	AP554
AP365	Standard	300	P171745	300	P171744	270	P171743	AP455
	High		P176633		P176632		P176631	AP555
AP366	Standard	400	P171748	400	P171747	320	P171746	AP456
	High		P176636		P176635		P176634	AP556

RMF = Recommended Maximum Flow in liters/minute with use of standard housing.

BPV = Bypass Valve Setting

S = Additional Service Clearance

High Collapse elements are non-stock items, request your sales contact offer and lead-time

## Alternative Housing Choices



Family	Alternative Housing (see anti-reverse flow valve or SAE Flange)	DIMENSIONS HOUSING																	POSSIBLE INDICATOR
		A	B	C	D	E	F	G	H	J	L	M	N	T	V	W	S	BPV	
		mm	mm	mm	mm	mm	mm	mm	mm	mm	mm	predilled holes	plugged	mm	mm	mm	mm	bar	
AP361	P766433	G1/2	110	78,5	215	33	9	50	57	M10	Hex 30	G1/2	yes				130	6	yes
AP362	P766434	G3/4	110	78,5	246	33	9	50	57	M10	Hex 30	G1/2	yes				165	6	yes
AP363	P766435	G1	110	78,5	345	33	9	50	57	M10	Hex 30	G1/2	yes				270	6	yes
AP364	P766436	G1 1/4	140	107	302	46	9	94	57	M12	Hex 30	G1/2	yes				180	6	yes
AP365	P766437	G1 1/2	140	107	395	46	9	94	57	M12	Hex 30	G1/2	yes				280	6	yes
AP366	P766438	G1 1/2	140	107	542	46	9	94	57	M12	Hex 30	G1/2	yes				420	6	yes
AP362	P766439	Flange 3/4"	110	78,5	246	33	9	50	57	M10	Hex 30	G1/2	yes	M10	23,8	50,8	165	6	no
AP363	P766440	Flange 1"	110	78,5	345	33	9	50	57	M10	Hex 30	G1/2	yes	M12	27,76	57,15	270	6	no
AP363	P766444	Flange 1"	110	78,5	345	33	9	50	57	M10	Hex 30	G1/2	yes	M12	27,76	57,15	270	6	yes
AP364	P766441	Flange 1" 1/4	140	107	302	46	9	94	57	M12	Hex 30	G1/2	yes	M14	31,75	66,68	180	6	no
AP364	P766445	Flange 1" 1/4	140	107	302	46	9	94	57	M12	Hex 30	G1/2	yes	M14	31,75	66,68	180	6	yes
AP365	P766442	Flange 1" 1/2	140	107	395	46	9	94	57	M12	Hex 30	G1/2	yes	M16	36,5	79,38	280	6	no
AP366	P766443	Flange 1" 1/2	140	107	542	46	9	94	57	M12	Hex 30	G1/2	yes	M16	36,5	79,38	420	6	no

P171945  
P171947  
P171944  
P761056



Standard Housing	HOUSING DIMENSIONS														CARTRIDGE DIMENSIONS			POSSIBLE INDICATOR	
	A	B	C	D	E	F	G	H	J	L	M	N	S	BPV	Including valve to avoid reverse flow through element	X	Y		Z
	mm	mm	mm	mm	mm	mm	mm	mm	mm	mm	predrilled holes	plugged	mm	bar		mm	mm		mm
P766427	G1/2	110	78,5	215	33	9	50	57	M10	Hex 30	G1/2	yes	130	6	no	87	54	27	
P766428	G3/4	110	78,5	246	33	9	50	57	M10	Hex 30	G1/2	yes	165	6	no	122	54	27	
P766429	G1	110	78,5	345	33	9	50	57	M10	Hex 30	G1/2	yes	270	6	no	230	54	27	
P766430	G1 1/4	140	107	302	46	9	94	57	M12	Hex 30	G1/2	yes	180	6	no	140	78	40	
P766431	G1 1/2	140	107	395	46	9	94	57	M12	Hex 30	G1/2	yes	280	6	no	240	78	40	
P766432	G1 1/2	140	107	542	46	9	94	57	M12	Hex 30	G1/2	yes	420	6	no	380	78	40	

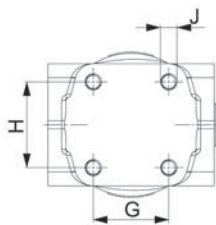
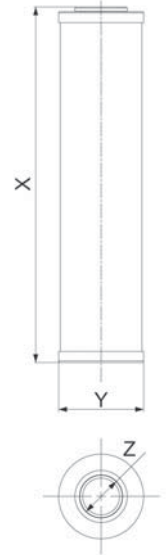
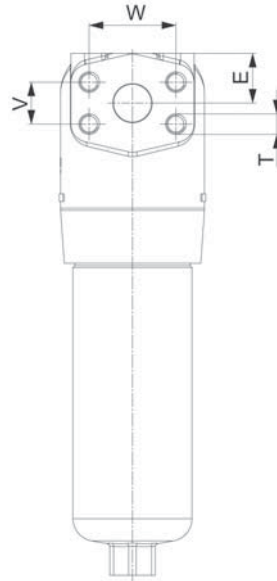
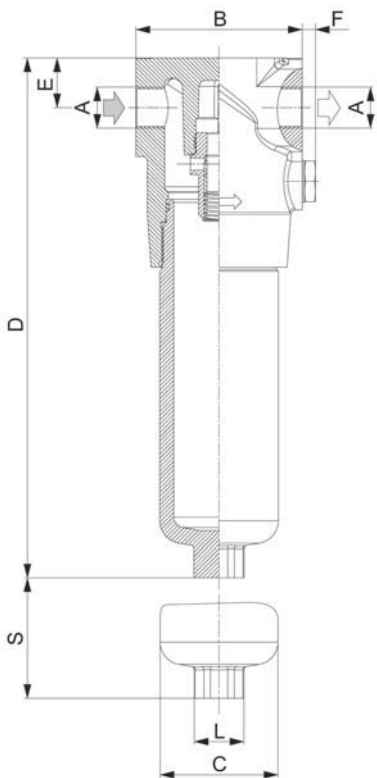

HIGH PRESSURE  
FILTERS

## Indicator Choices

Part	Kind		Reference Drawing	Setting (bar)	Contact	Pro-tection Class	Cable Clamp	Max. Values	Remark
P171945	Visual	Differential	H	5					
P171947	Electrical + Visual	Differential	K	5	Normally Open/ Closed	IP65	PG11	250V AC; 30 VDC; 5A res. and ind.	
P171944	Electrical + Visual	Differential	K	5	Normally Open/ Closed	IP65	PG11	250V AC; 30 VDC; 5A res. and ind.	with thermostat at min. temperature at 30°C
P761056	Electrical	Differential	L	5	Normally Open/ Closed	IP65	PG11	30 V DC; 30 V AC; 0,5 A res. and 0,2 A ind.	

## Installation & Service Guidelines

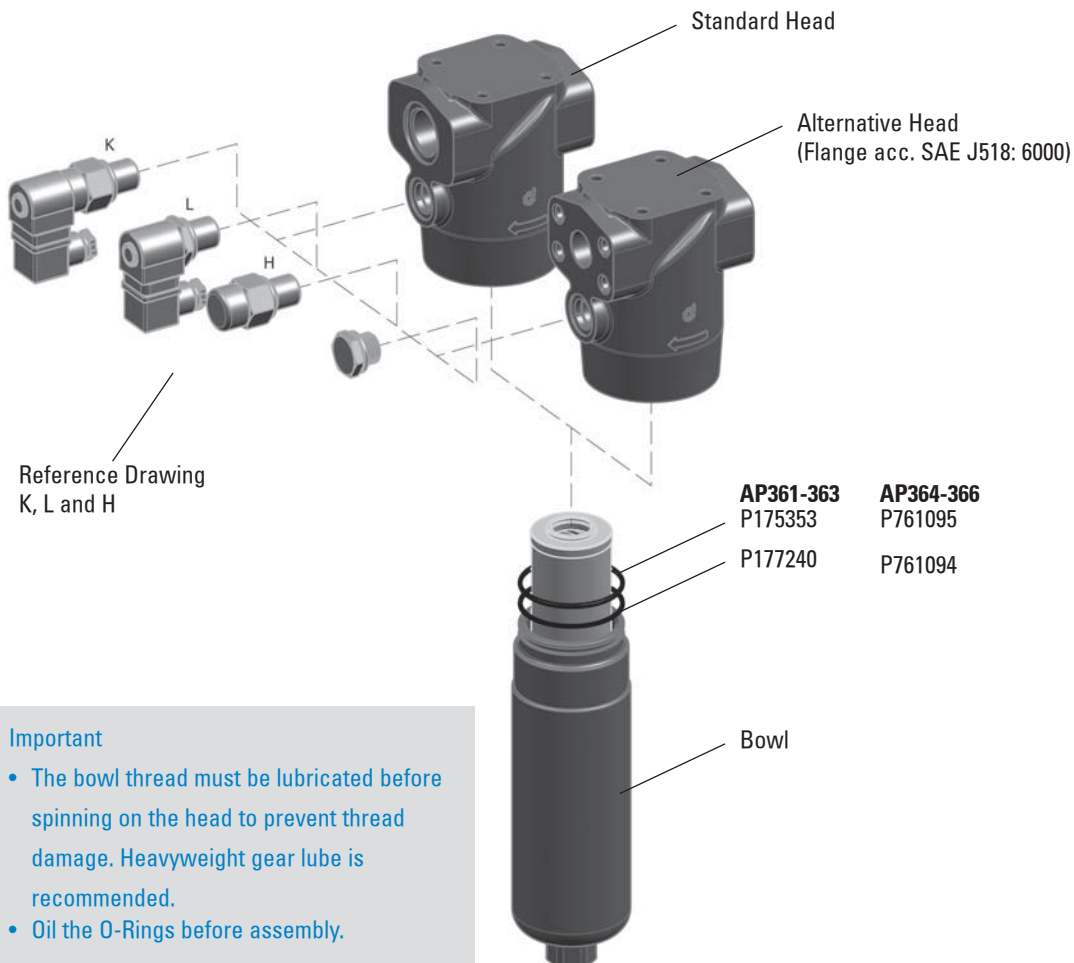

HIGH PRESSURE FILTERS

## Performance Curves

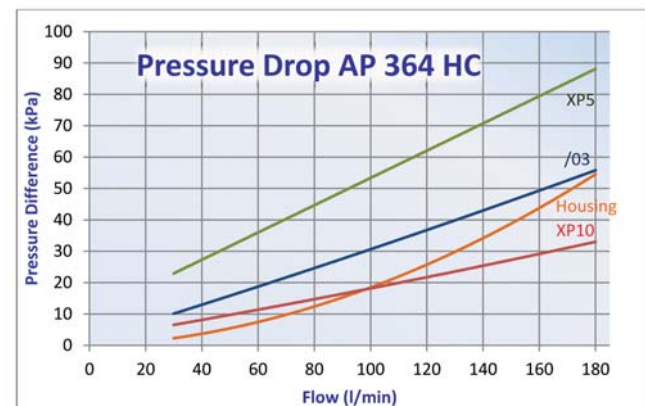
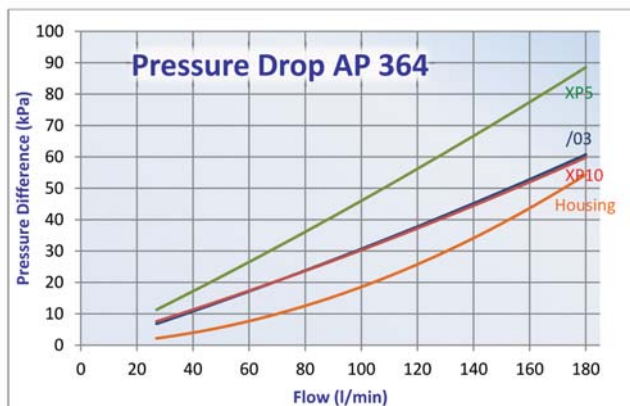
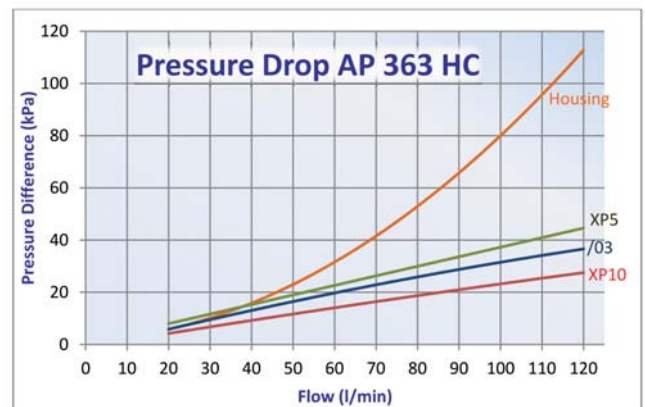
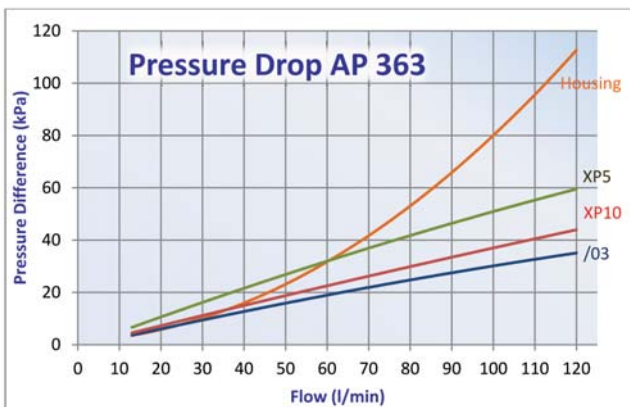
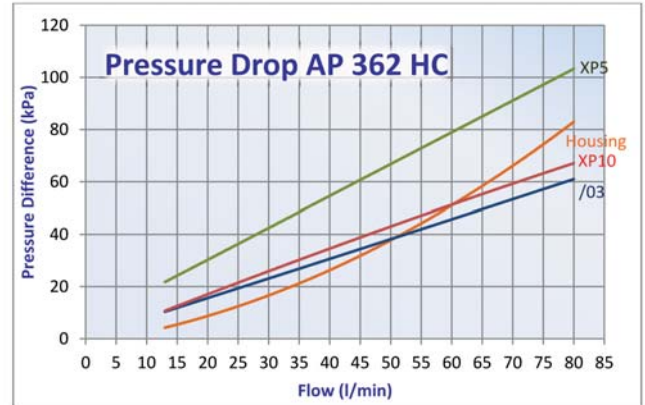
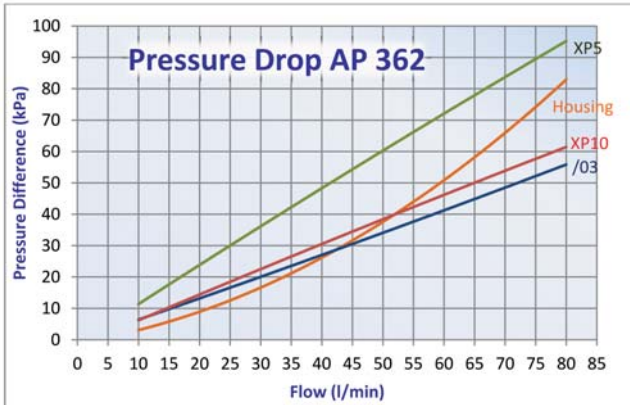
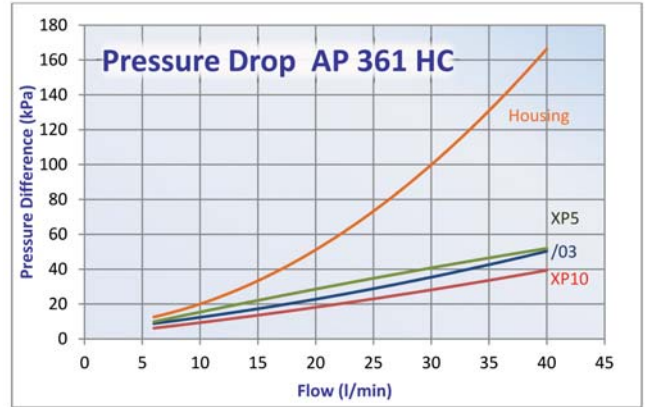
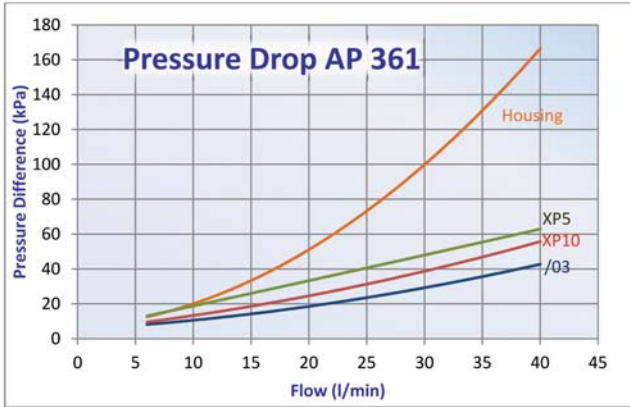

HIGH PRESSURE  
FILTERS



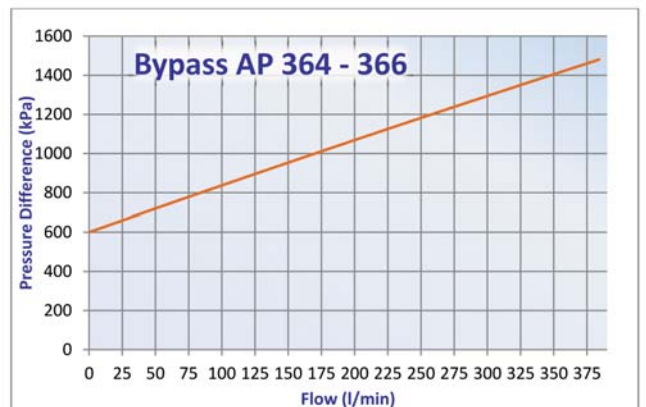
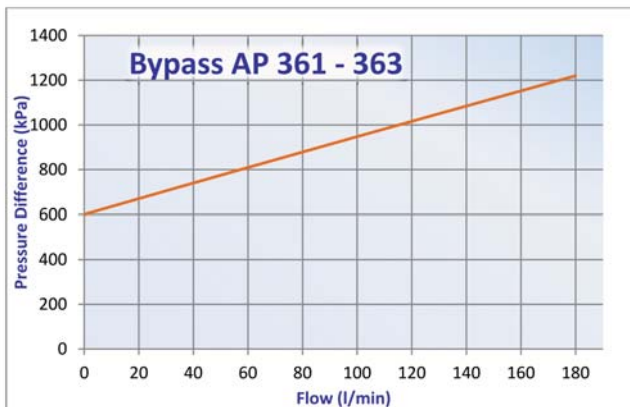
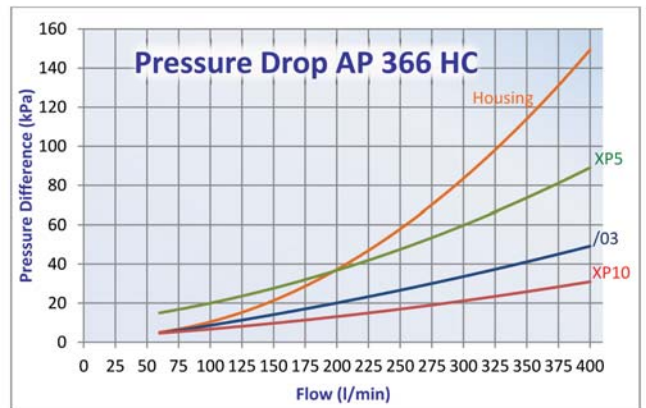
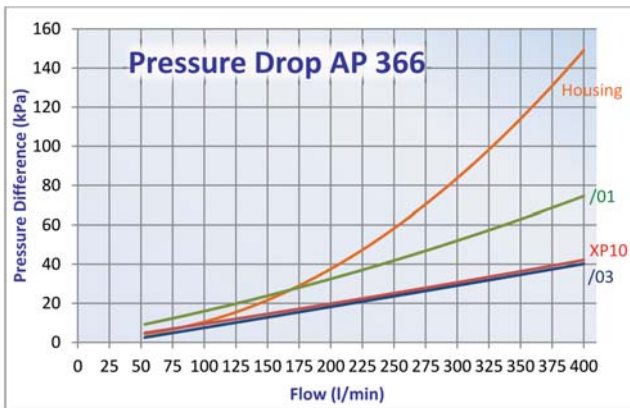
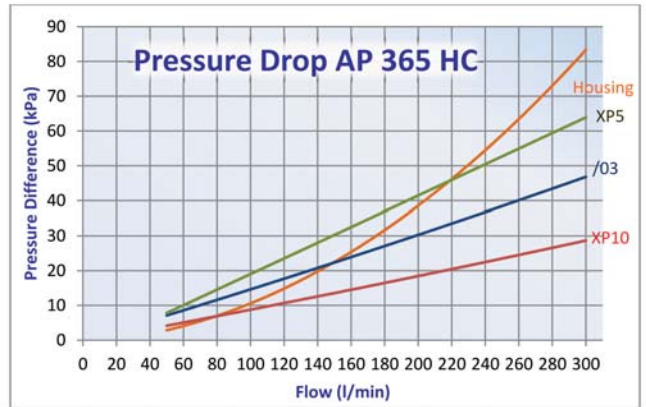
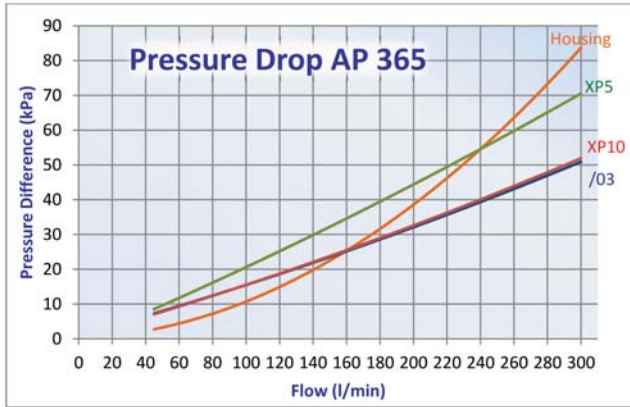

HIGH PRESSURE FILTERS